

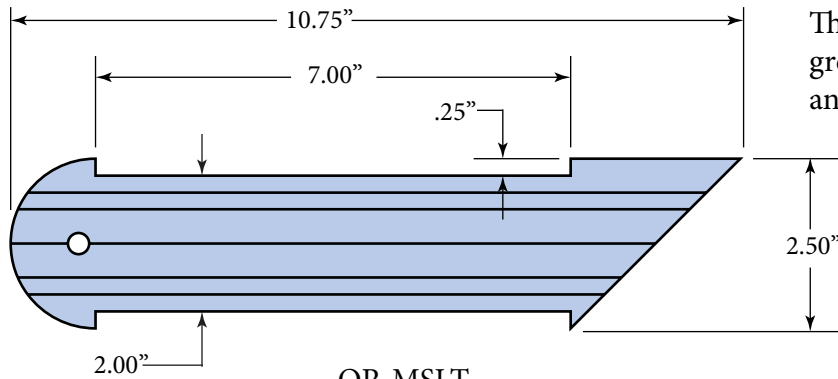

Straight Line Template Instructions



The Straight Line Template is great for quick and easy block and border designs.

QR-MSLT
1/4" thick

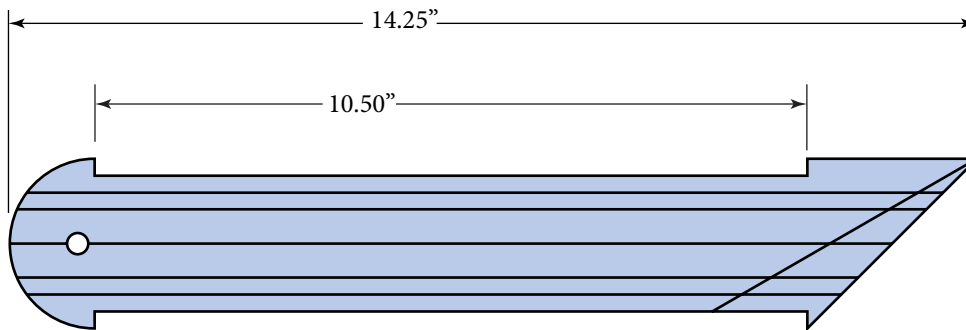

QR-MSLT-M
1/4" thick

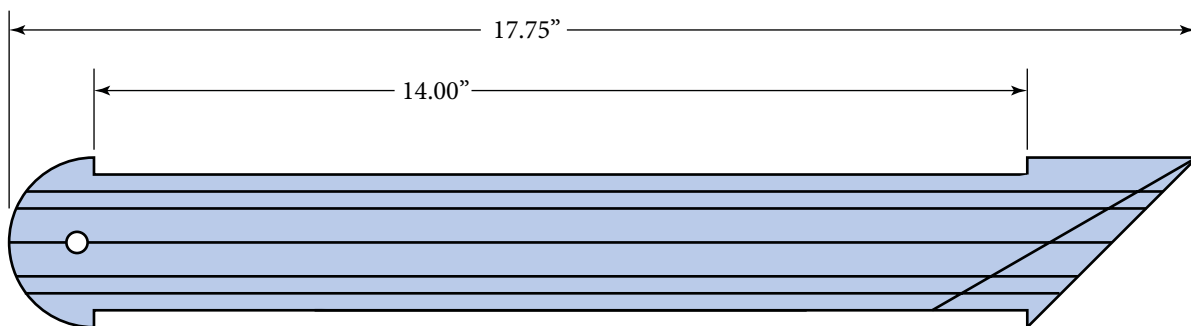





QR-MSLT-L
1/4" thick

If you are using the template(s) to quilt around (such as a long/mid-arm machine or high shank home machine), you must use 1/4" acrylic thickness. If you are on a low shank home machine, you must use 3/16" acrylic thickness. If you are on a machine that is stationary, you may find it helpful to put some type of agent such as Grip Stop Dots or spray adhesive on the templates. Before using, peel any film/paper masking from the templates so you can see through the clear plastic.

Note:

- 1) When using the template(s) to quilt around you must have a round, thick foot on your machine as well as a base (such as an extend-a-base or ruler base).
- 2) When using the template(s) to quilt around you will be stitching 1/2" larger (the width of your foot) or 1/4" wider if only using a portion of the template (the distance from your needle to the outer edge of your foot).
- 3) You may need to start with drawn/chalked guidelines or seam lines on your quilt.

| SYMBOL GUIDE | |
|---|----------------------|
|  | ruler foot |
|  | start |
|  | stop and needle down |
|  | back stitching |

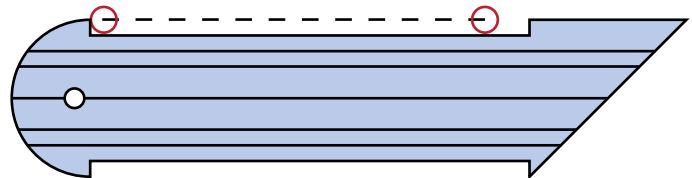

The Straight Line Tool is excellent for creating all manner of straight lines. Each edge is “indented” by 1/4” to aid in proper placement on quilts.

STITCH IN THE DITCH

Align the top of the indentation on either side of the ruler with the seam line. Stitch along the indentation to “stitch in the ditch” easily. Move up or down as you prefer. Use the illustrations below as your guide.

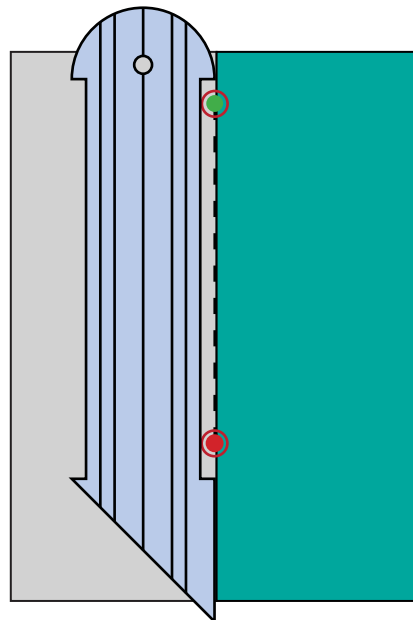
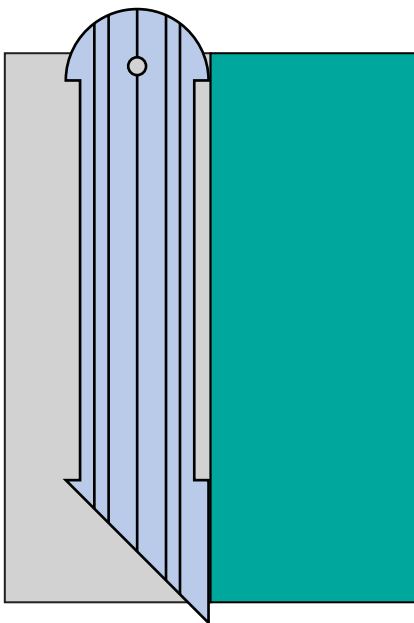

RAIL FENCE

Create a fill of parallel lines as shown below. The template's 1/4" etched lines allow you to easily create stitching equidistant apart.

Stitch your first row of stitching. Align one of the etched lines on the ruler to your first stitched line and stitch your next parallel line. Continue for desired width. Use the illustrations below as your guide.

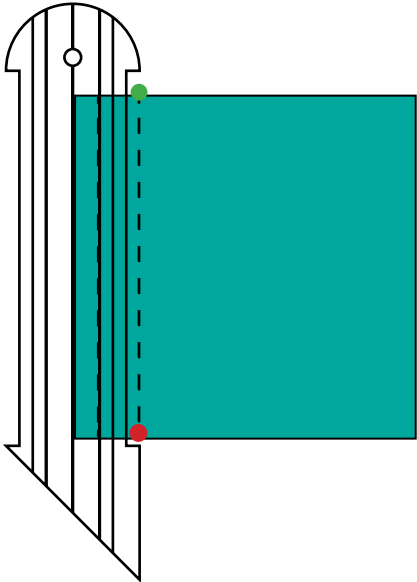

Border Area

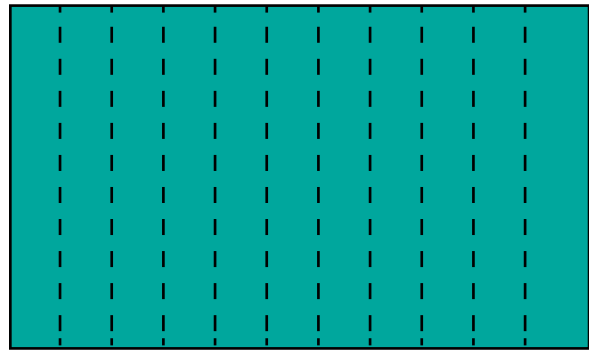

CROSS HATCHING

Great for cross hatching or making your own designs. Align the top of the indentation on either side of the ruler with the corner of the block, and the bottom of the indentation where you want to end your line. Stitch along the indentation to the end. Move up or down as you prefer. Use the illustrations below as your guide.

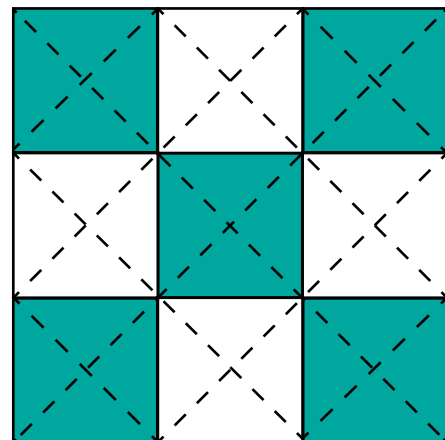
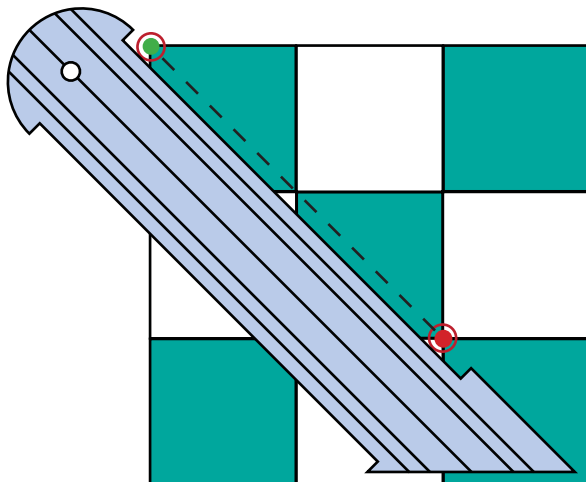

MOBIUS SQUARE

Create this intricate looking mobius design by simply rotating the Straight Line Tool inside the square as shown.

Start square here

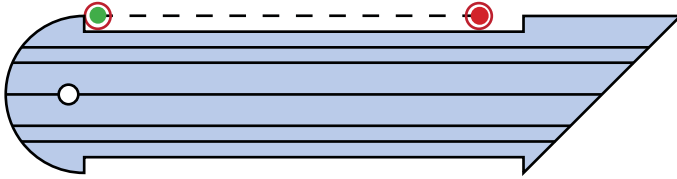

Begin mobius design after finishing all four sides of the square.

