

Oval Chain Template Instructions

The Oval Chain is great for quick and easy block and border designs.



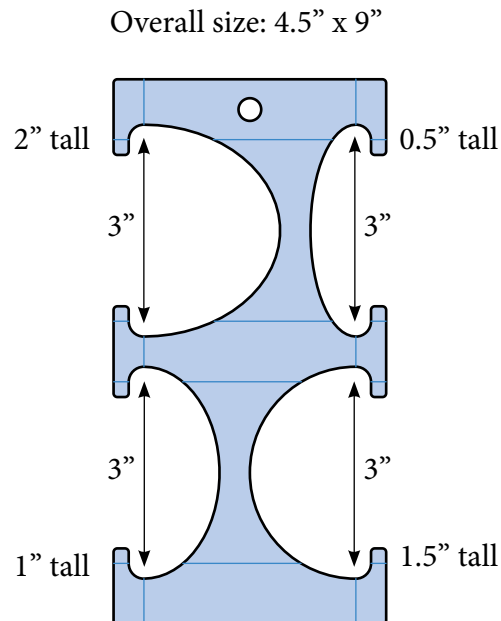

There are 4 ovals which are all 3" wide, but 4 different heights - 1/2", 1", 1.5", and 2".

MQT-SWAG3
1/4" thick

HMQT-OSWG
3/16" thick



If you are using the template(s) to quilt around (such as a long/mid-arm machine or high shank home machine), you must use 1/4" acrylic thickness. If you are on a low shank home machine, you must use 3/16" acrylic thickness. If you are on a machine that is stationary, you may find it helpful to put some type of agent such as Grip Stop Dots or spray adhesive on the templates. Before using, peel any film/paper masking from the templates so you can see through the clear plastic.

| SYMBOL GUIDE | |
|---|----------------------|
|  | ruler foot |
|  | start |
|  | stop and needle down |
|  | back stitching |

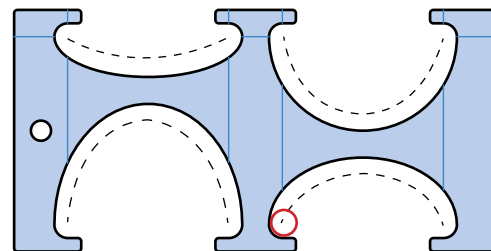

Note:

- 1) When using the template(s) to quilt around you must have a round, thick foot on your machine as well as a base (such as an extend-a-base or ruler base).
- 2) When using the template(s) to quilt around you will be stitching 1/2" larger (the width of your foot) or 1/4" wider if only using a portion of the template (the distance from your needle to the outer edge of your foot).
- 3) You may need to start with drawn/chalked guidelines or seam lines on your quilt.

CREATE A SWAG BORDER

Use the etched lines in the tool to align the largest opening over the seam or line. Place the left-hand side of the opening on the foot. Stitch from one end of the opening to the other. Needle down.

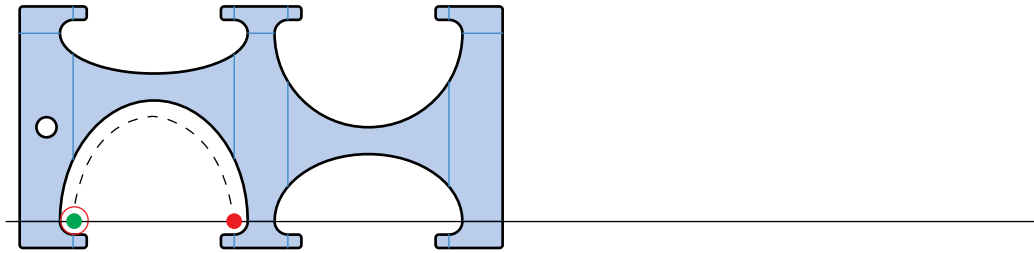

Slide the tool to the right to return to the starting point and repeat to desired length. Needle down.

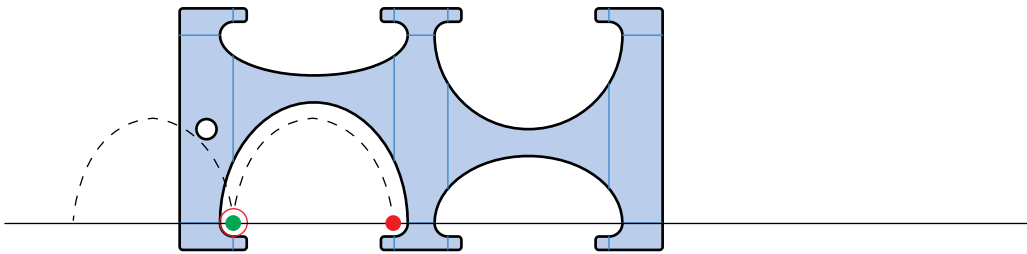

Completed 1st row.

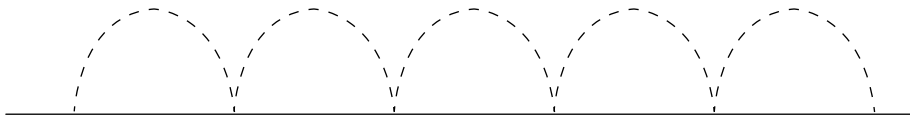

Change to the next size down and align the base of the template to the guideline and stitch in the reverse direction. Move tool to the left and continue to the end of your row.

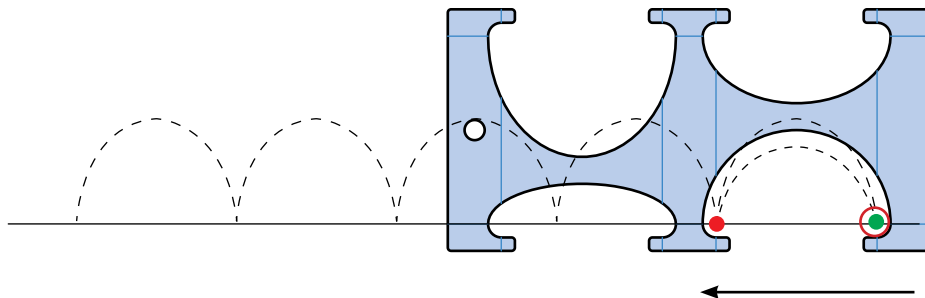

Completed 2nd row.

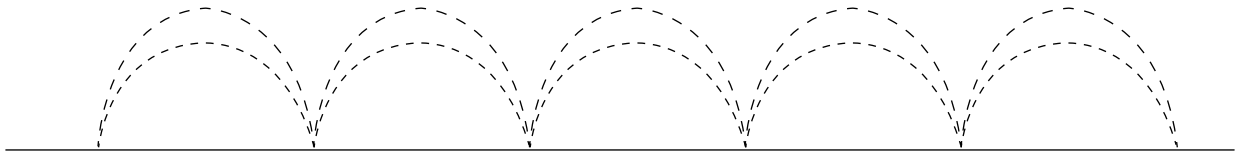

Align the next size opening over the seam or line. Place the left-hand side of the opening on the foot. Stitch from one end of the opening to the other. Move template to the right and stitch the next oval. Repeat to the end of the row. Needle down.

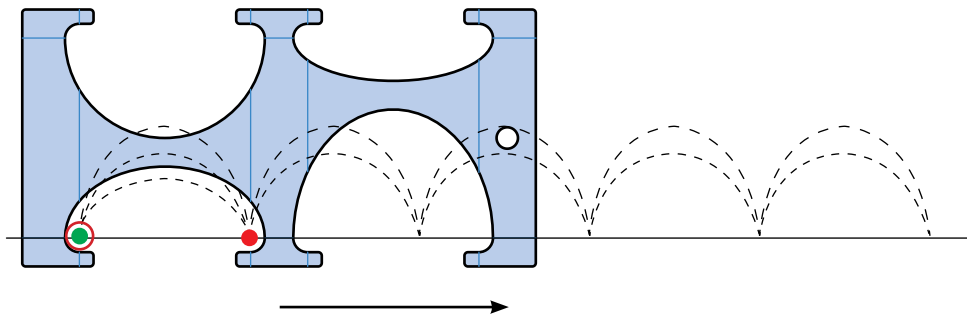

Completed 3rd row.

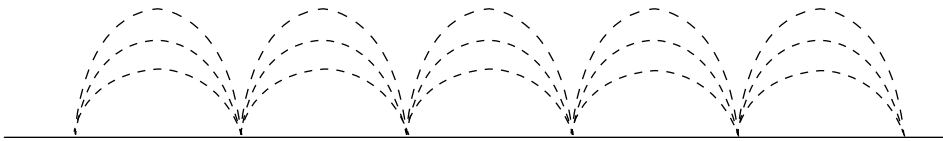

Change to the last size oval and align it to the ruler foot and guideline. Stitch from right to left for this last row of the swag. Move the template to the left, align and stitch. Repeat to the end of the row.

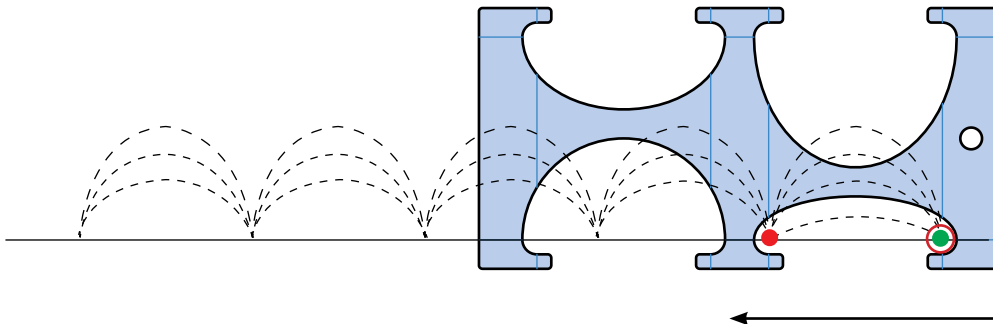

Completed Swag Border

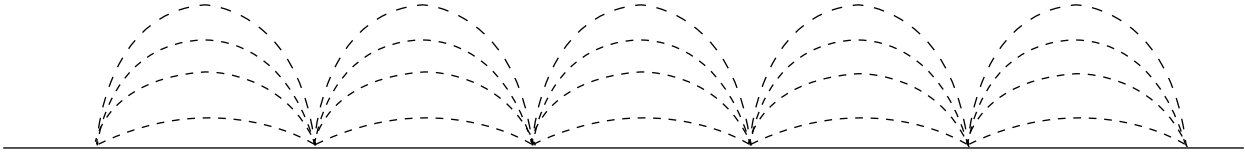

VARIATIONS USING A SINGLE SIZE

Create a row of stitches on top of the line or below, or combine both for many variations.

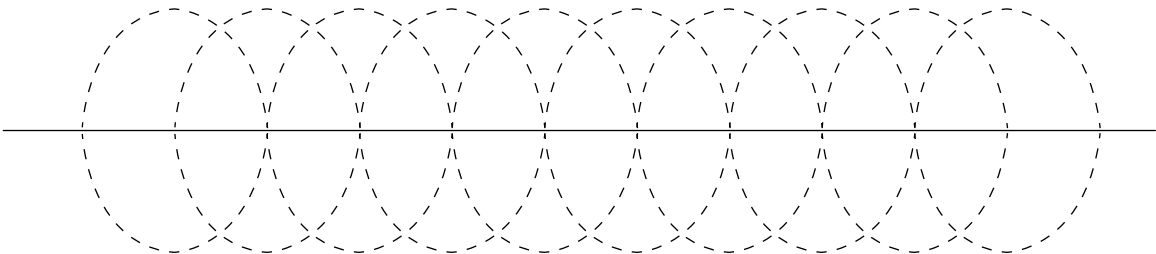
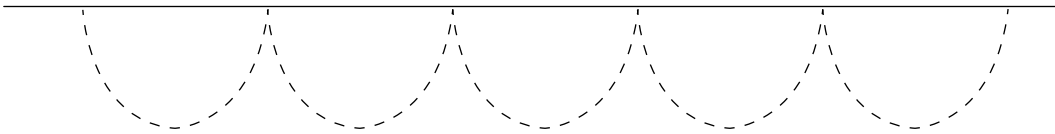
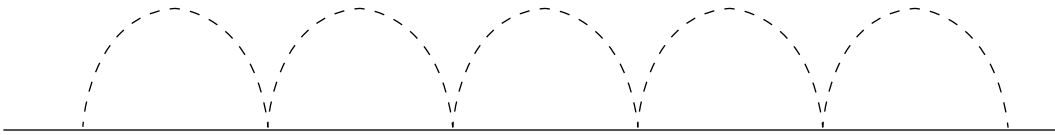
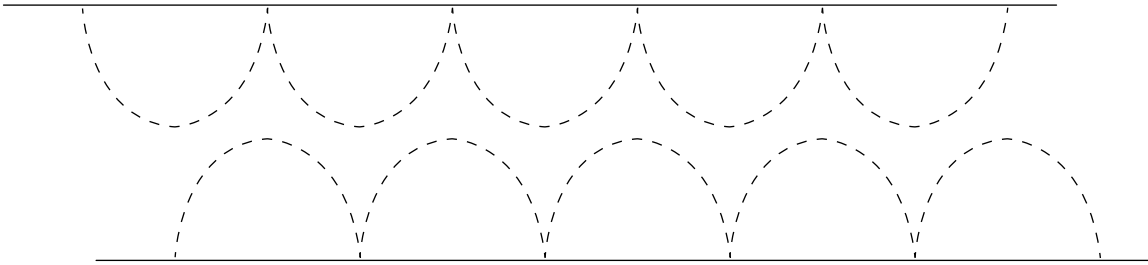

CREATE A WAVY LINE

Use the etched lines in the tool to align the chosen opening over the seam or line. Place the left-hand side of the opening on the foot. Stitch from one end of the opening to the other. Needle down.

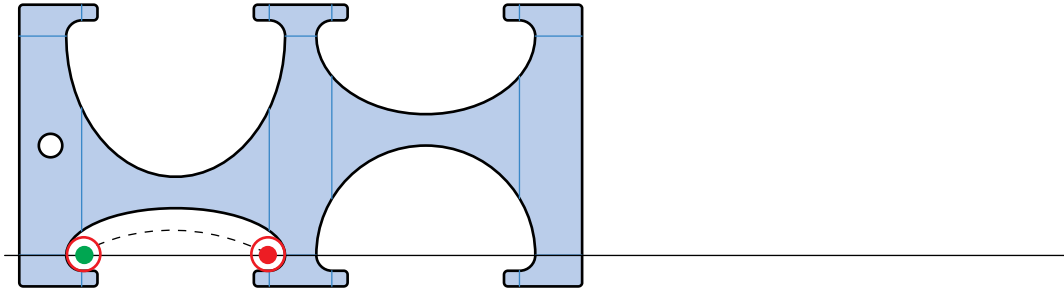

Swing the tool around the foot (using the foot as a pivot point) until the etched lines are again lined up on the quilt. Stitch from one end of the opening to the other. Needle down. Repeat to the end of the row.

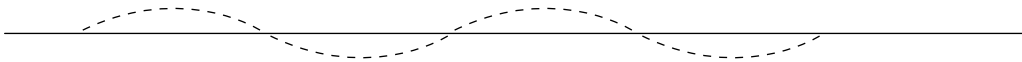
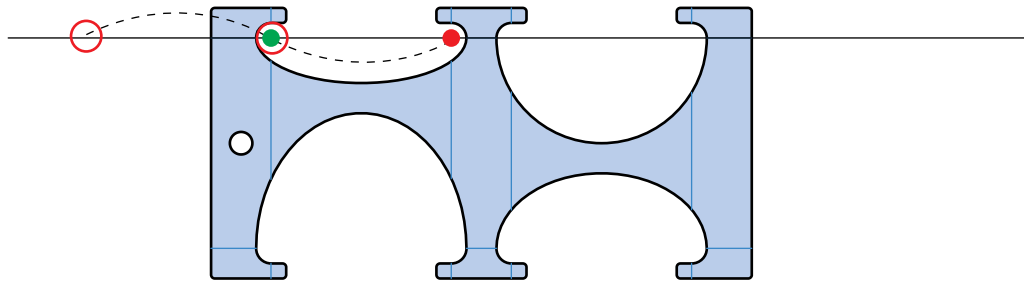

Reverse these steps for an oval chain.

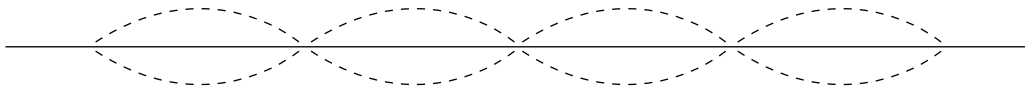

BLOCK DESIGNS

Choose the oval size that you want. Align the etched lines on the template to one of the seamlines on your block. Stitch from A to B. Needle down. Turn the template 90°. Fit template to your ruler foot and align to your seamline. Stitch from A to B. Use the illustrations below as your guide.

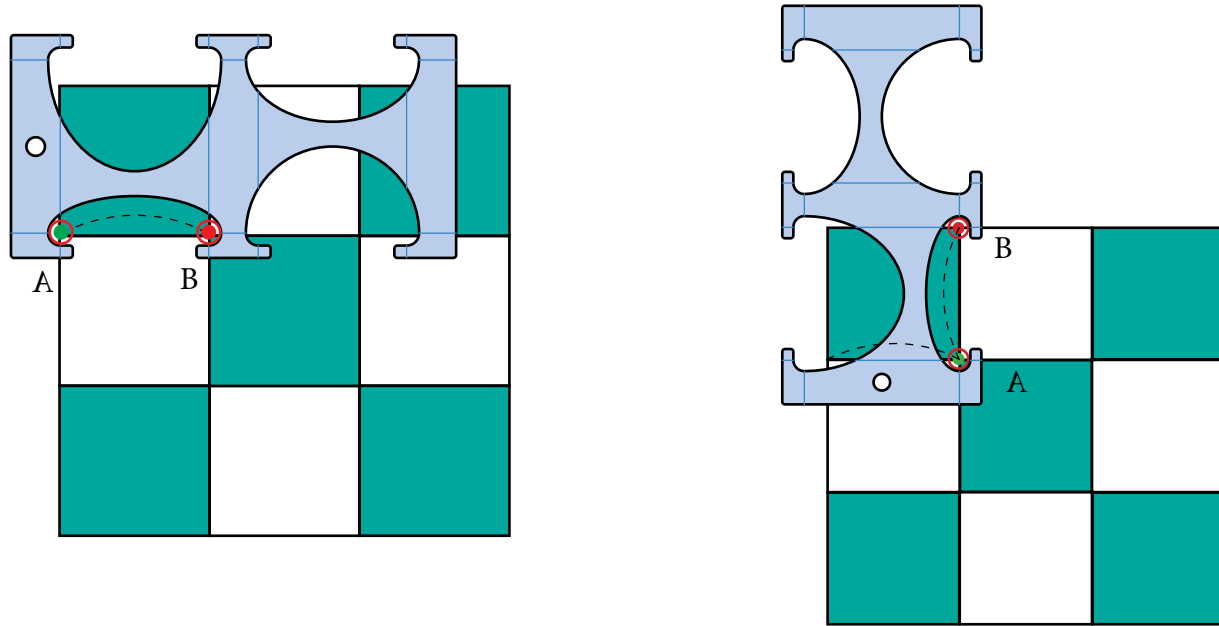

Continue stitching around the 4 sides of the square. Repeat for the desired design. Follow the red arrows for suggested continuous stitching path.

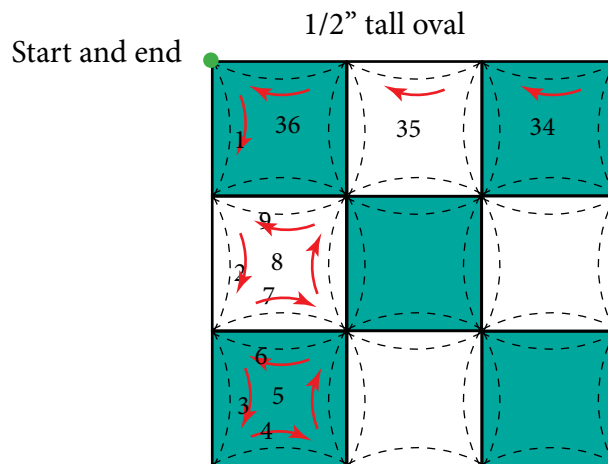

1" tall oval

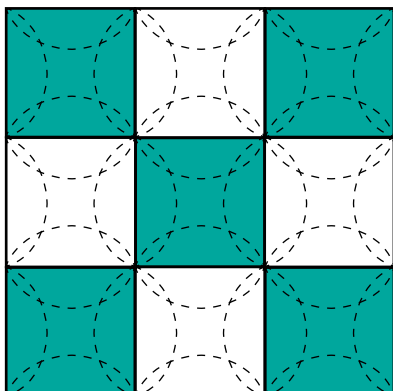

1.5" tall oval

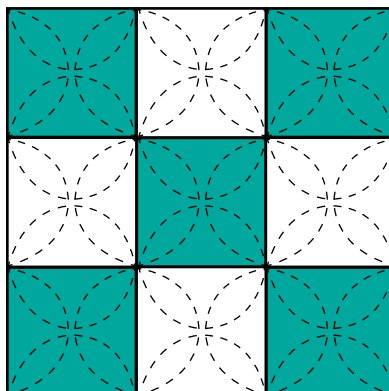

2" tall oval

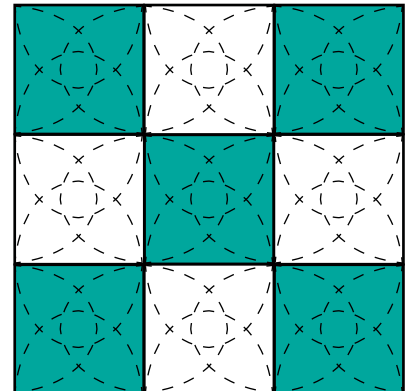

VARIATIONS

Combine different sizes and stagger your starting point for endless design possibilities.

