

4-in-1 Template Instructions

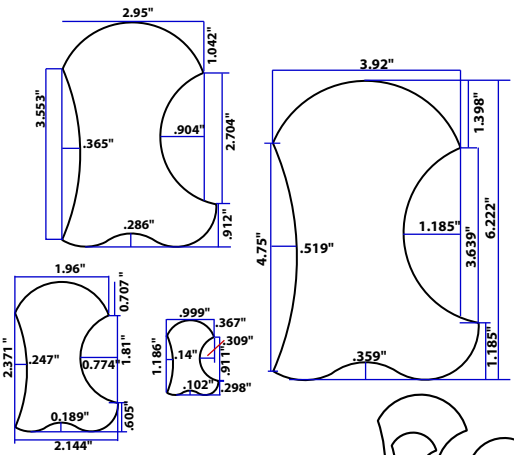

SF-DT06
1/8" thick - Semi-nested

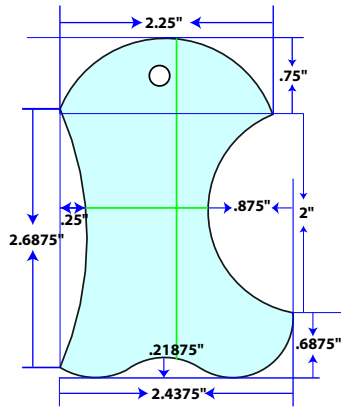

MQT-MN06
1/4" thick

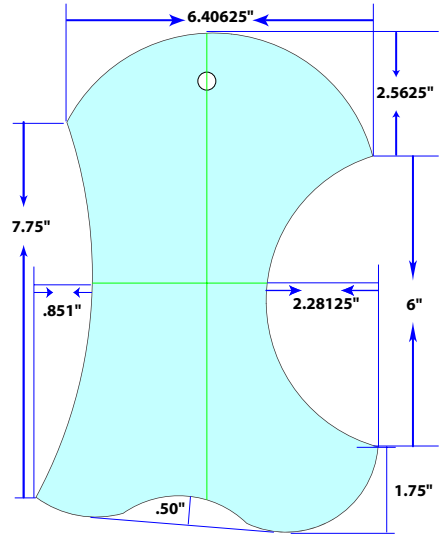

MQT-SM06
1/4" thick

If you are using the template(s) to draw or cut around, then 1/8" is a sufficient thickness. If you are using the template(s) to quilt around (such as a long- or mid-arm machine), you **must** use the 1/4" acrylic thickness. * The 1/4" tools have etched lines on them that mark the center of the rectangle the tool fits within. Before using the tools, peel any film/paper masking from the templates so you can see through the clear plastic.

***Note:**

- 1) When using the template(s) to quilt around you must have a round, thick foot on your machine as well as a base (such as an extend-a-base or ruler base).
- 2) When using the template(s) to quilt around you will be stitching a 1/2" larger (the width of your foot), or 1/4" wider if only using a portion of the template (the distance from your needle to the outer edge of your foot).

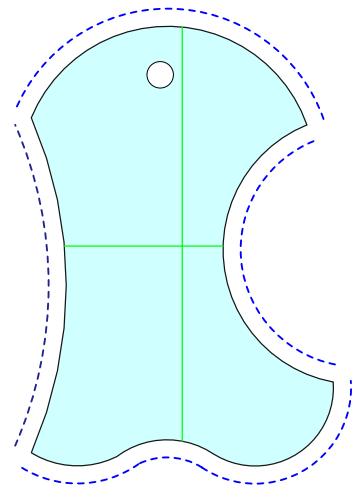

The 4-in-1 template is a four-sided tool with four different curves/arcs on it. Using curves and arcs you can create a variety of designs. Curves/arcs are great for border designs.

Scallop Border

- 1) Position the template so the arc you desire is on the drawn line or seam of the quilt.
- 2) Stitch or draw from one side of the arc to the other. (See Illustration #1)
- 3) Slide the 4-in-1 template down the drawn line or seam.
- 4) Starting where you stopped, stitch or draw the arc. (See Illustration #2)
- 5) Repeat until desired length is achieved. (See Illustration #3)

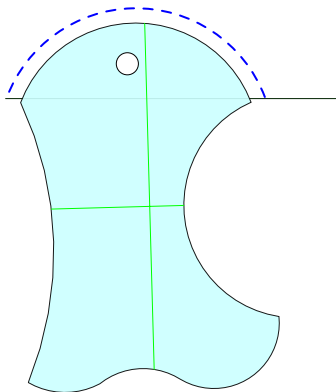

Illustration #1

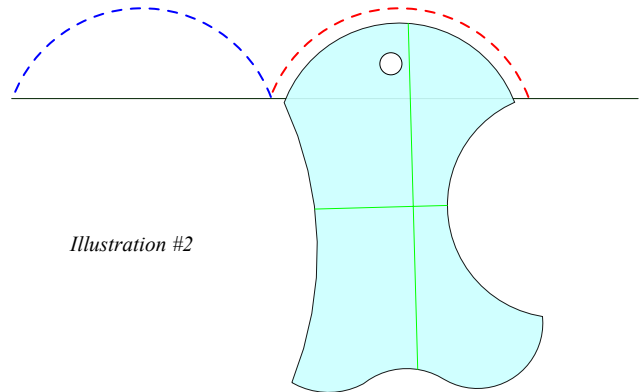

Illustration #2



Illustration #3

Note/Tip: You do not have to use the full arc as shown. If you wish to use a smaller portion of the arc, simply use blue painter's tape as an alignment guide.

Wave Border

- 1) Begin by selecting a 4-in-1 arc and following Step 1 and 2 of Scallop Border above. Upon completion of Step 2, you will have a single arc stitched. (See Illustration #4)
- 2) Flip the template to the opposite side of the drawn line or seam and then slide the template until it is positioned so you can stitch the desired arc on the other side of the drawn line or seam. (See Illustration #5)
- 3) Continue flipping and sliding until wave is desired length. (See Illustration #6)

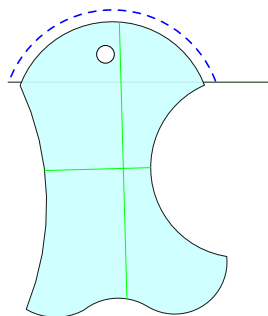

Illustration #4

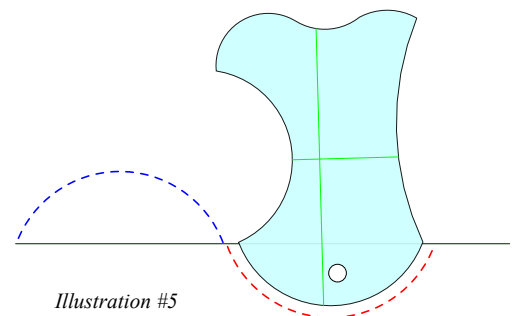

Illustration #5

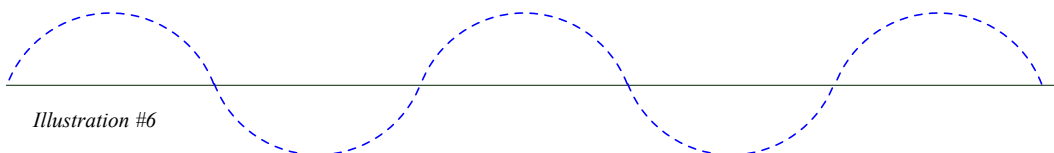

Illustration #6

Slide Wave Border

- 1) Begin by selecting the multiple arc side of the 4-in-1 and stitch or draw the arc. (See Illustration #7)
- 2) Slide the 4-in-1 template down the line until the first portion of the arc fits into the last of the stitched or drawn arc. (See Illustration #8)
- 3) Starting where you stopped, stitch or draw the arc. (See Illustration #8)
- 4) Repeat until desired length is achieved. (See Illustration #9)

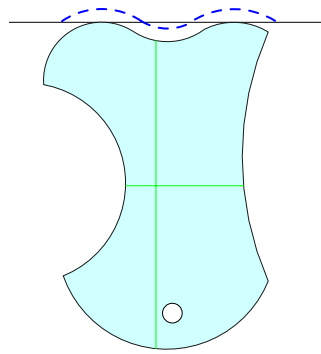

Illustration #7

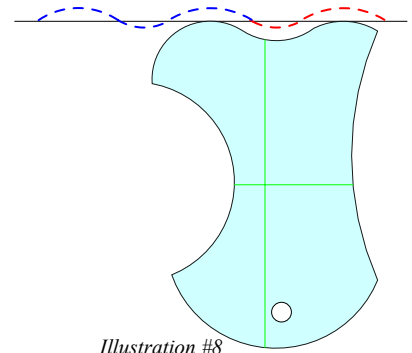

Illustration #8

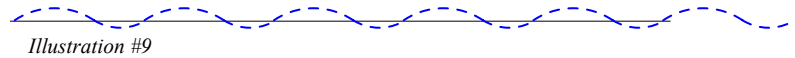

Illustration #9

Lacey Border

- 1) Begin by selecting the multiple arc side of the 4-in-1 and stitch or draw the arc. (See Illustration #10)
- 2) Slide the 4-in-1 template down the line.
- 3) Starting where you stopped, stitch or draw the arc. (See Illustration #11)
- 4) Repeat until desired length is achieved. (See Illustrations #12)

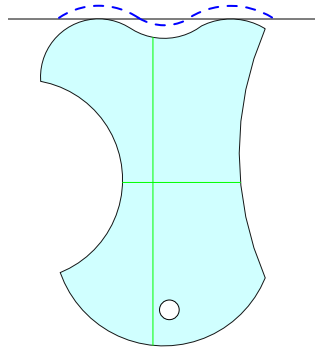

Illustration #10

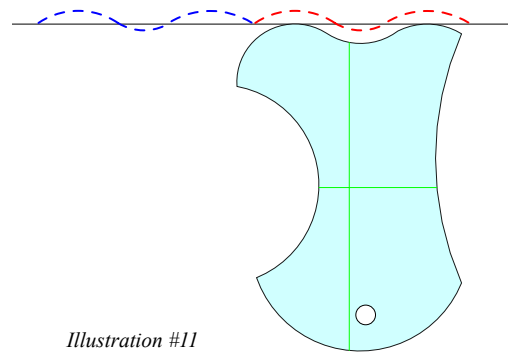

Illustration #11

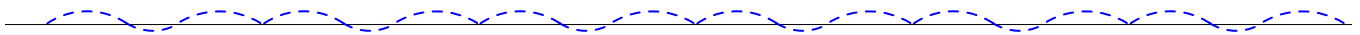

Illustration #12

Wave Flip Border

- 1) Begin by selecting the multiple arc side of the 4-in-1 and stitch or draw the arc. (See Illustration #13)
- 2) Flip the template to the opposite side of the drawn line or seam and then slide the template until it is positioned so you can stitch the desired arc on the other side of the drawn line or seam. (See Illustration #14)
- 3) Continue flipping and sliding until wave is desired length. (See Illustration #15)

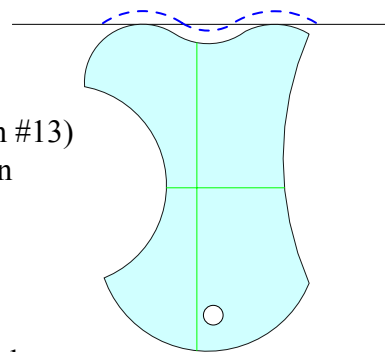

Illustration #13

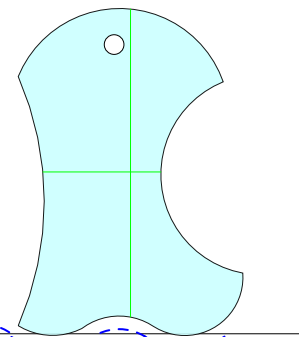

Illustration #14

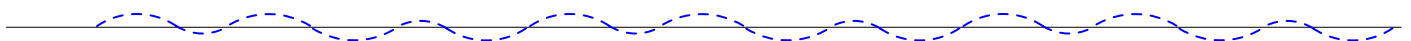

Illustration #15

NOTE: All examples shown are depicted as being stitched not drawn.

Continuous Line Curves on Patches

The shallow concave side of the 4-in-1 is ideal for the continuous line curve used on 4- and 9-patches. Place the shallow concave side of the 4-in-1 template $1/4''$ away from the corners of the square. Stitch from one corner to the opposite corner (See Illustration #16). Pivot the shallow concave side to the next side of the square. Stitch from corner to corner (See Illustration #17). Continue until all sides are done (See Illustration #20).

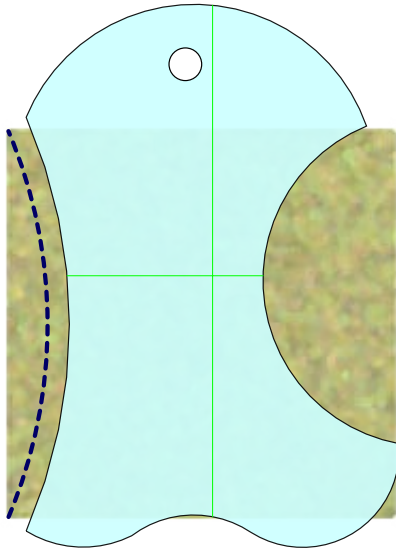

Illustration #16

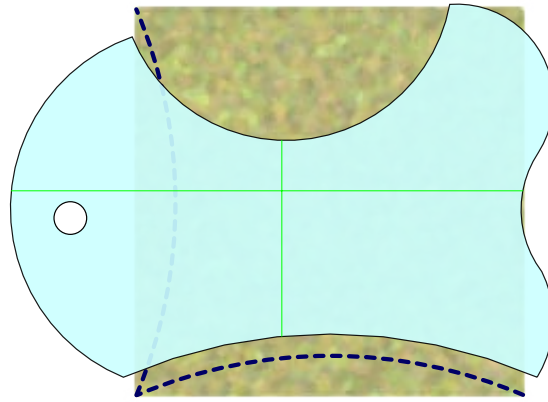

Illustration #17

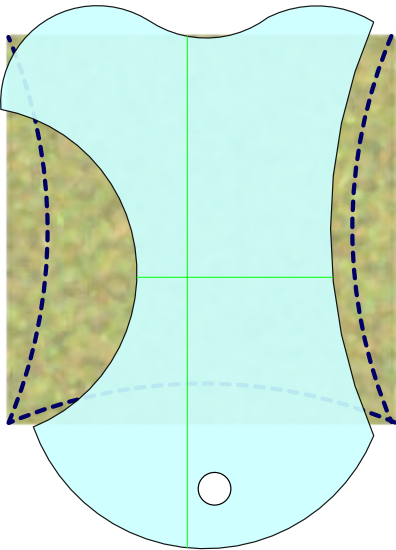

Illustration #18

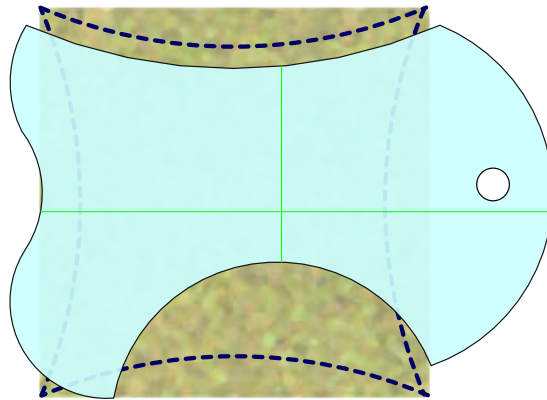

Illustration #19

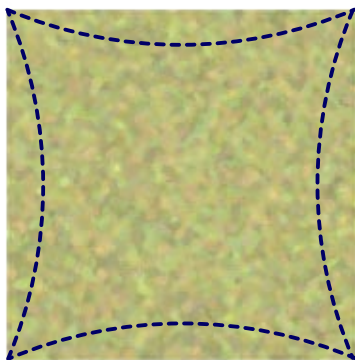

Illustration #20

See next two pages for suggested stitching paths.

NOTE: All examples shown are depicted as being stitched not drawn. If you are using this template to draw around, you can line up directly on the corners and not $1/4''$ away as depicted.

Continuous Line Stitching Path for 4-Patch

Illustrated below is one stitching path for a 4-patch.

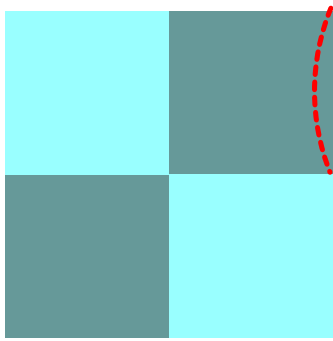

Step 1

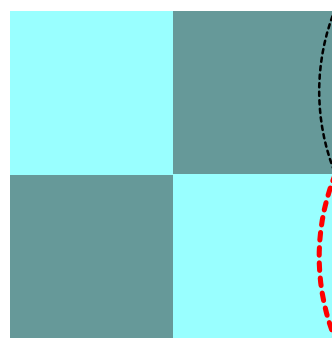

Step 2

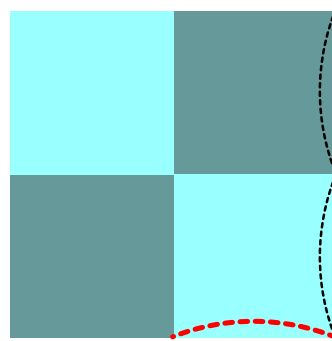

Step 3

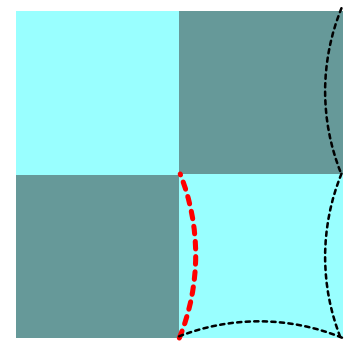

Step 4

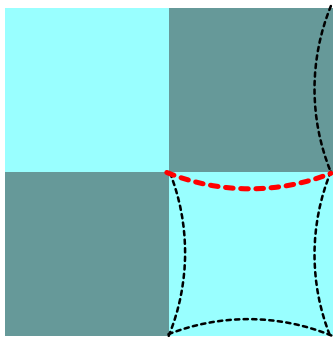

Step 5

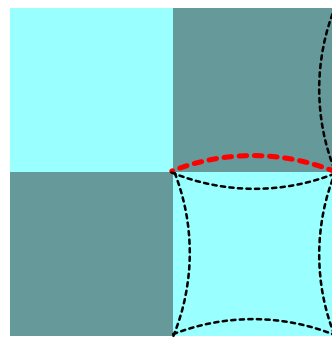

Step 6

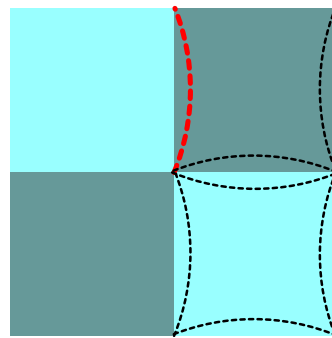

Step 7

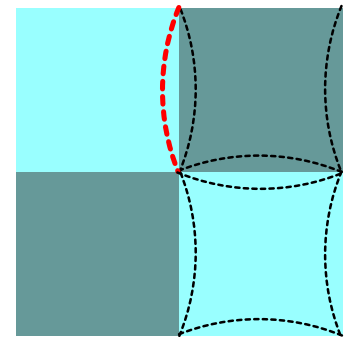

Step 8

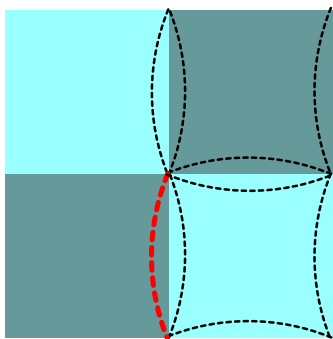

Step 9

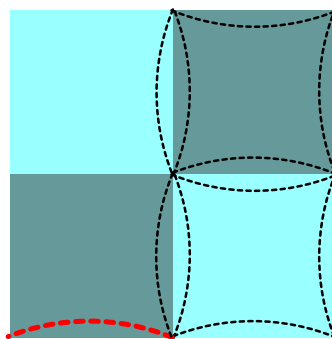

Step 10

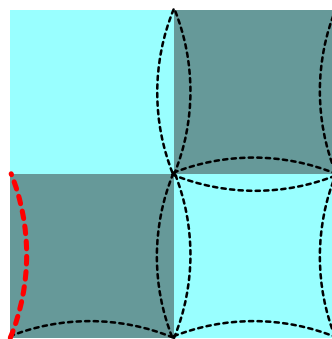

Step 11

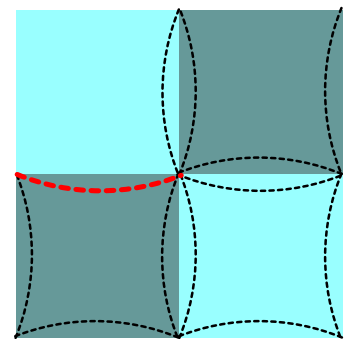

Step 12

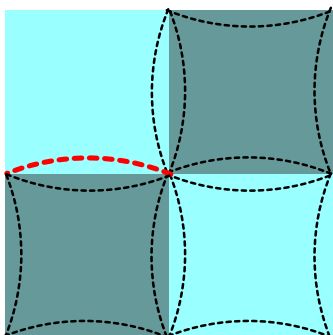

Step 13

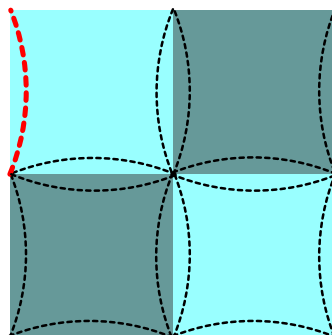

Step 14

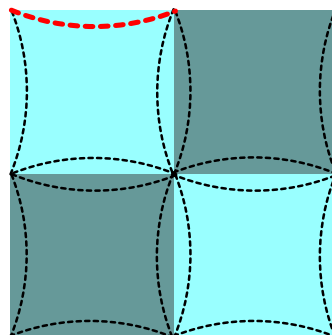

Step 15

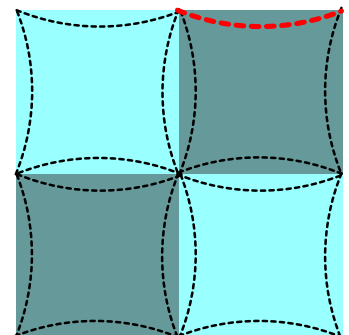

Step 16

Continuous Line Stitching Path for 9-Patch

Illustrated below is one stitching path for a 9-patch.

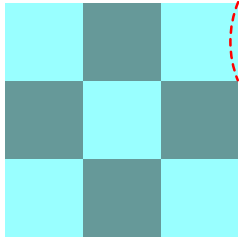

Step 1

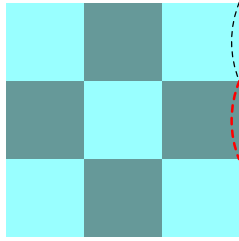

Step 2

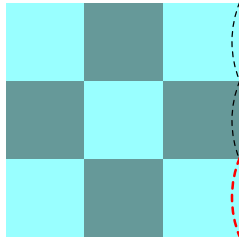

Step 3

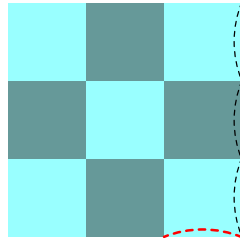

Step 4

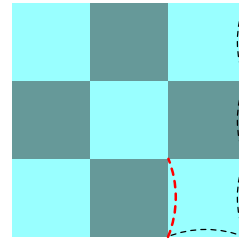

Step 5

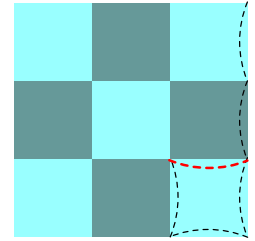

Step 6

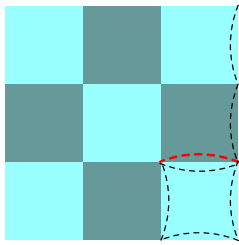

Step 7

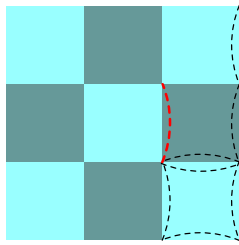

Step 8

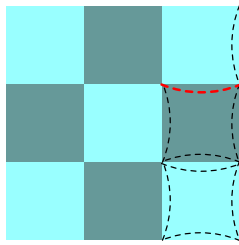

Step 9

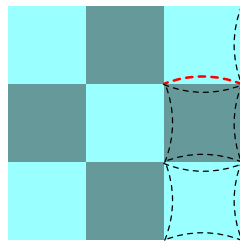

Step 10

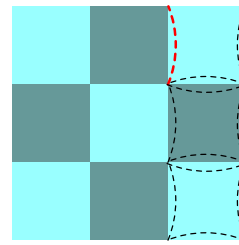

Step 11

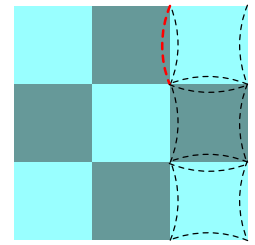

Step 12

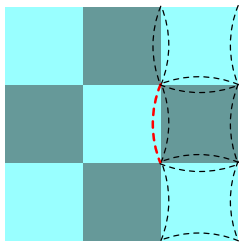

Step 13

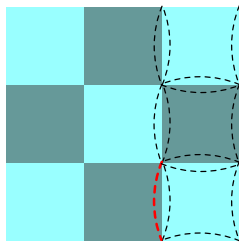

Step 14

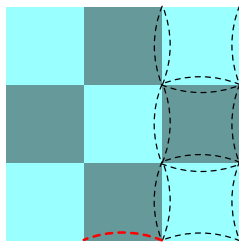

Step 15

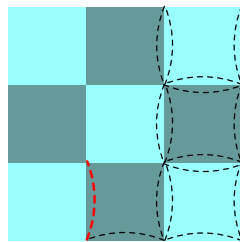

Step 16

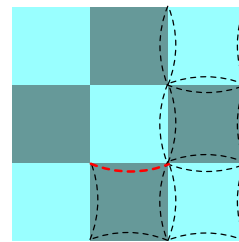

Step 17

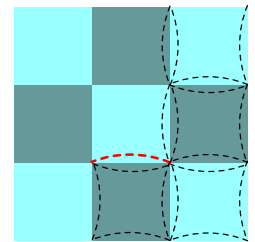

Step 18

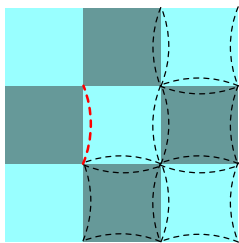

Step 19

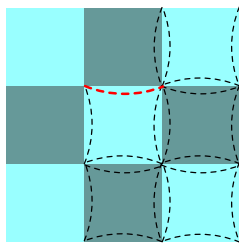

Step 20

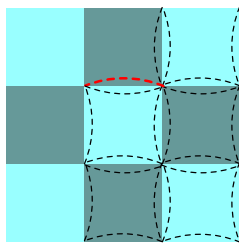

Step 21

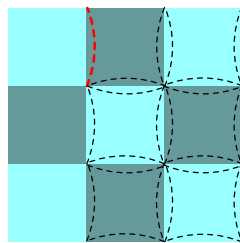

Step 22

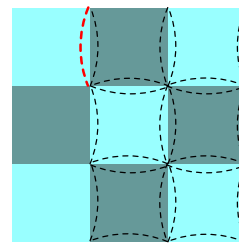

Step 23

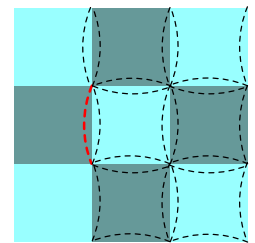

Step 24

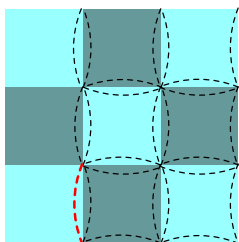

Step 25

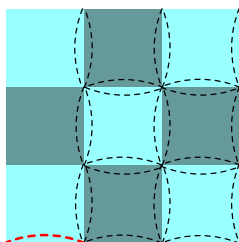

Step 26

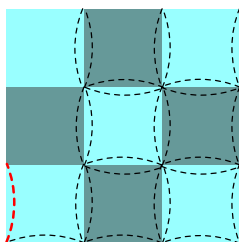

Step 27

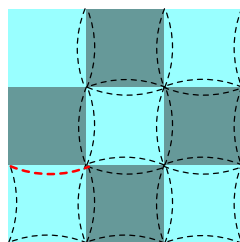

Step 28

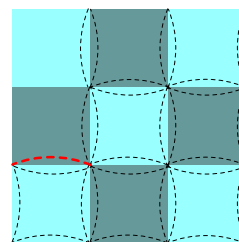

Step 29

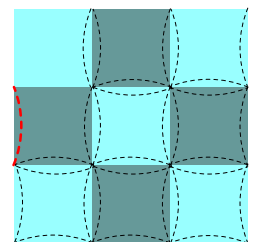

Step 30

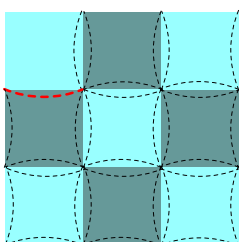

Step 31

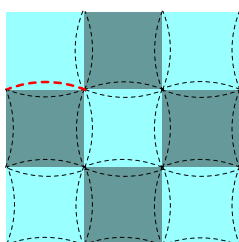

Step 32

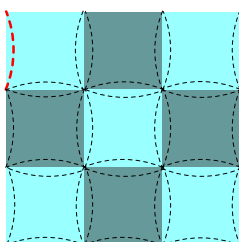

Step 33

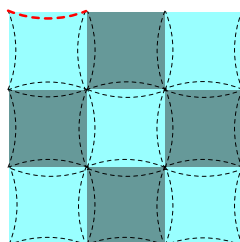

Step 34

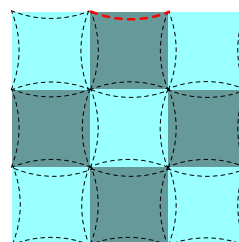

Step 35

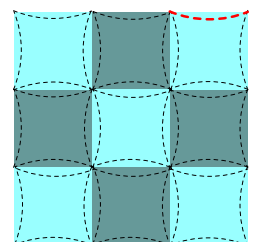

Step 36

Curlicue and Diamond

Use the deep concave side of the 4-in-1 template to create this charming pattern. Start by finding the center of each side of the square(s). Line the deep concave 1/4" from the center marks (See Illustration #21). Stitch from one center mark to the other. Rotate the 4-in-1 template to the next center marks as shown (See Illustration #22). Stitch from center mark to center mark. Continue until all four center marks are used (See Illustration #25).

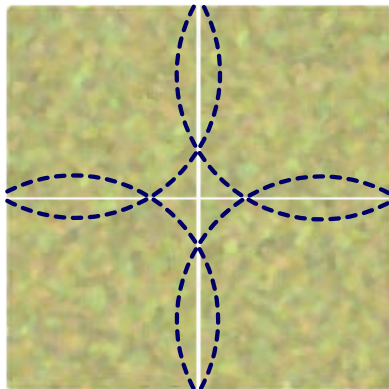
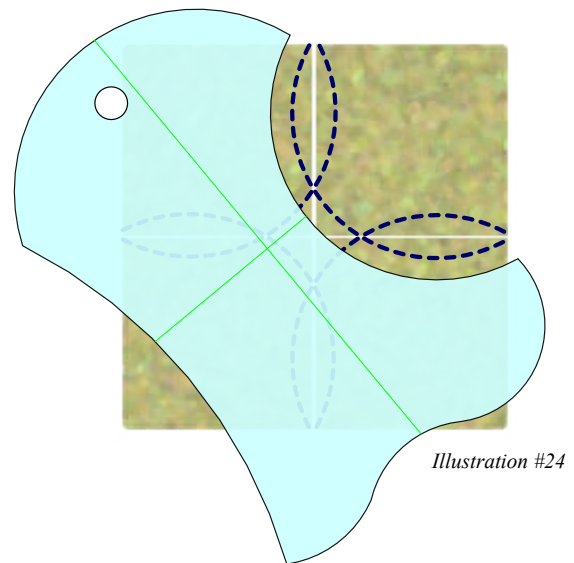
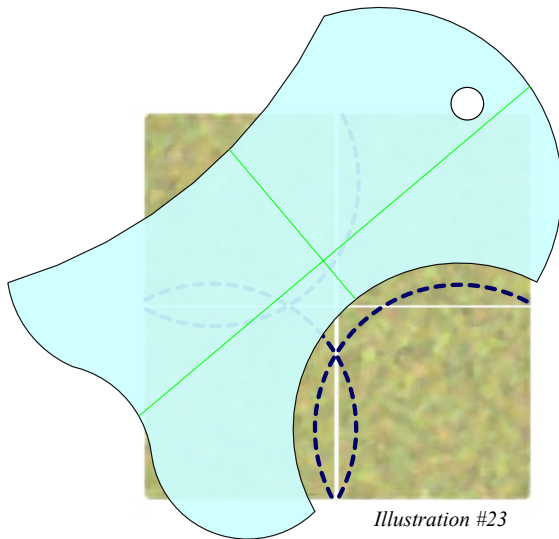
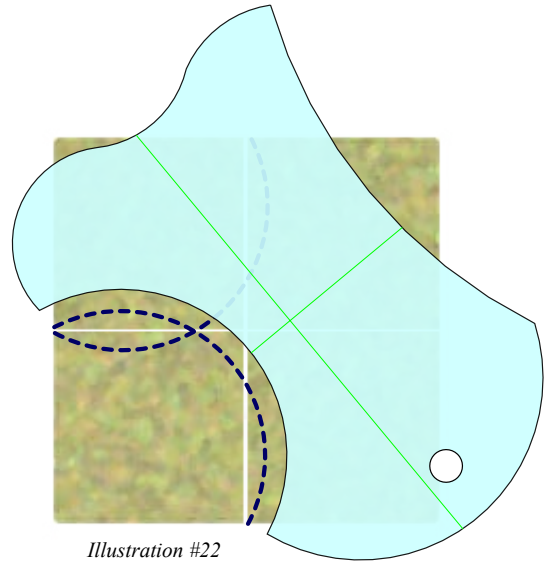
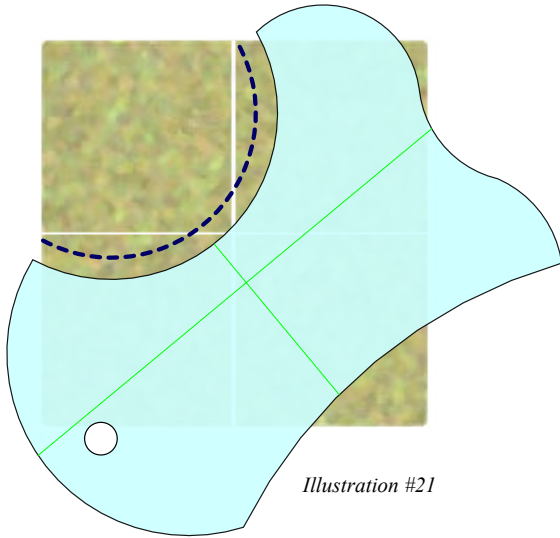

NOTE: All examples shown are depicted as being stitched not drawn. If you are using this template to draw around, you can line up directly on the center marks and not 1/4" away as depicted.

Curlicue and Diamond II

Use the deep convex side of the 4-in-1 template to create an alternative look. Place the deep convex side of the 4-in-1 template 1/4" away from the corners of the square (See Illustration #26). Stitch from one corner to the opposite corner. Pivot the deep convex side to the next side of the square (See Illustration #27). Stitch from corner to corner. Continue until all sides are done (See Illustration #30).

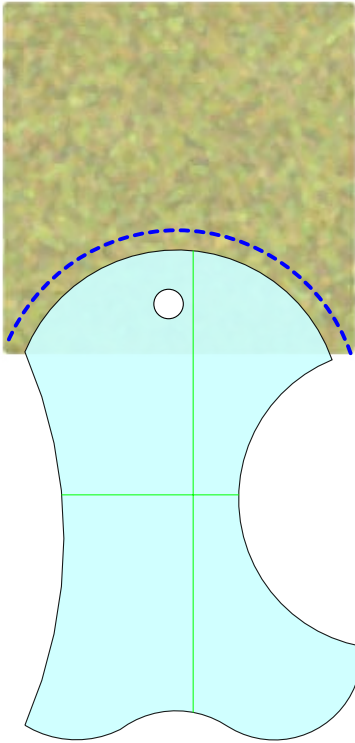

Illustration #26

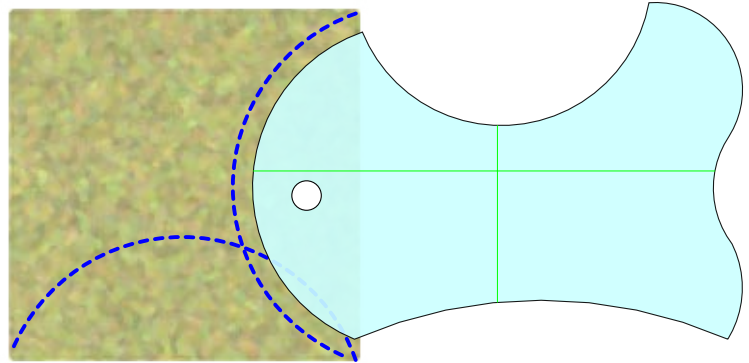

Illustration #27

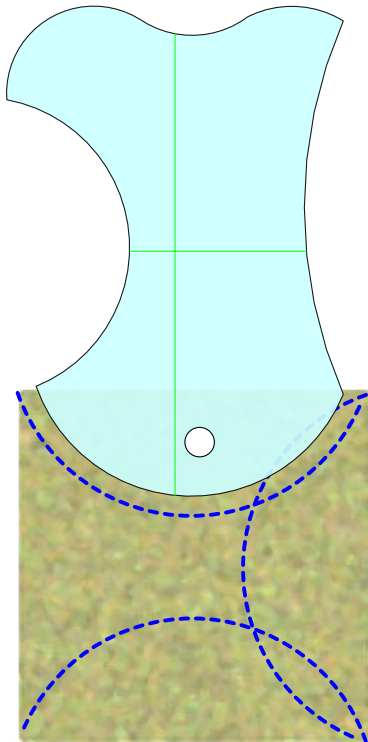

Illustration #28

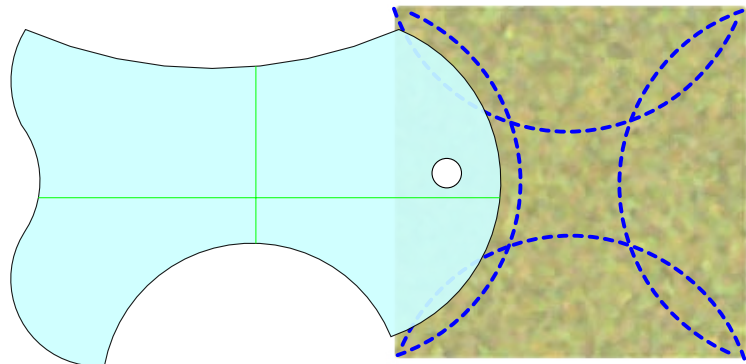

Illustration #29

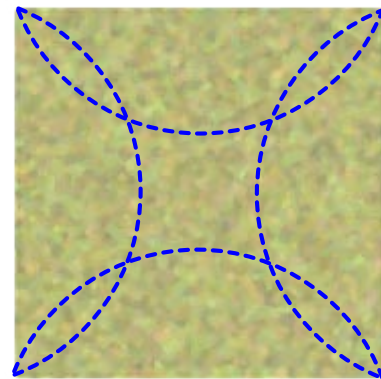

Illustration #30

NOTE: All examples shown are depicted as being stitched not drawn. If you are using this template to draw around, you can line up directly on the corners and not 1/4" away as depicted.

Block Pattern

In this pattern, use 3/4 of the template. First you will need to have a set of cross hairs to align the template appropriately. If your block is a 4-patch, you can use the seams as your cross hairs. If not, use a grid stencil or ruler to mark the cross hairs.

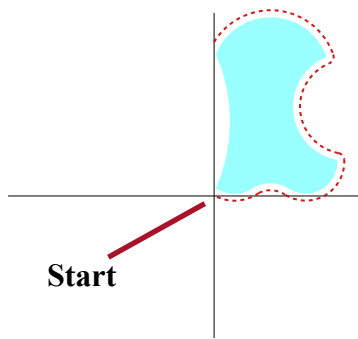

Illustration #31

Place the 4-in-1 template with the shallow concave edge against the vertical cross hair as shown. Stitch from the center of the square moving around the outside of the template to the top of the tool stopping at the vertical line. Do not stitch the shallow concave side.

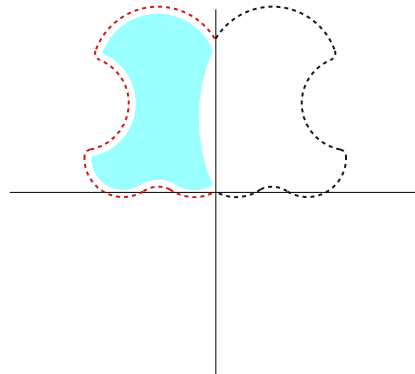

Illustration #32

Flip the template to the left of the vertical line keeping the shallow concave side against the vertical line. Stitch from the vertical line at the top of the template to the center of the square.

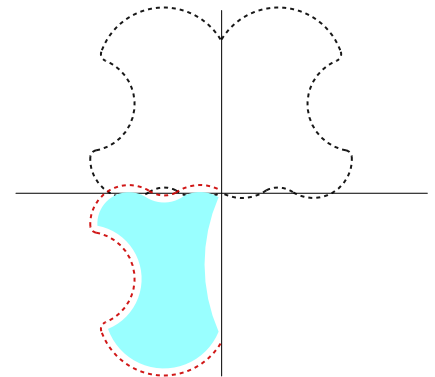

Illustration #33

Flip the template to below the horizontal line keeping the shallow concave side against the vertical line. Stitch from the center of the square around the outside of the template to the vertical line.

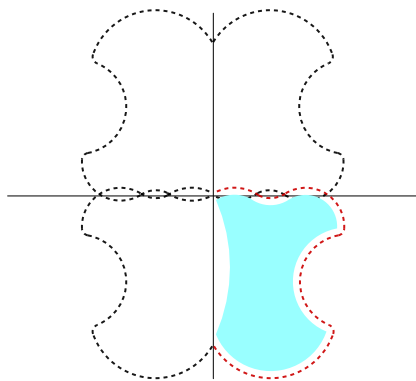

Illustration #34

Flip the template to the right of the vertical line keeping the shallow concave side against the vertical line. Stitch from the vertical line to the center of the square.

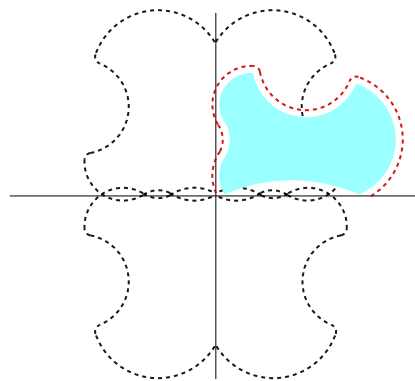

Illustration #35

Rotate the template so that the shallow concave side is above the horizontal line and the template is on the right side of the vertical line. Stitch from the center of the square around the outside to the horizontal line.

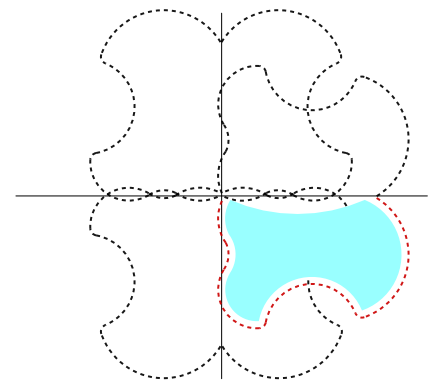

Illustration #36

Flip the template below the horizontal line keeping the shallow concave side against the horizontal line. Stitch from the horizontal line to the center of the square.

Block Pattern - Continued

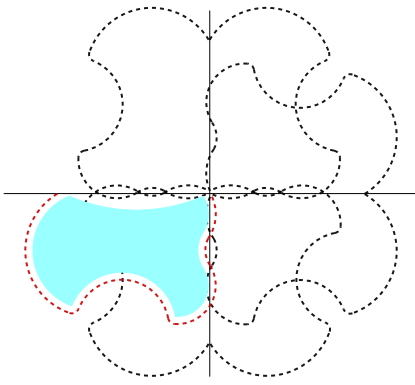

Illustration #37

Flip the template to the left of the vertical line keeping the shallow concave side against the horizontal line. Stitch from the center of the square around the outside to the horizontal line.

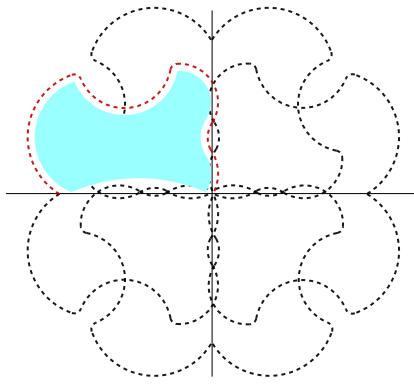

Illustration #38

Flip the template above the horizontal line keeping the shallow concave side against the horizontal line. Stitch from the horizontal line to the center of the square.

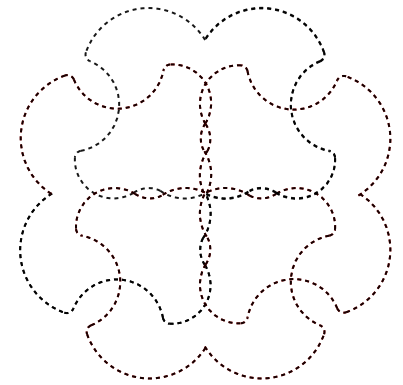

Illustration #39

Finished stitched design.