

NAUTILUS SPIRAL TOOLS

Borders, Blocks & Corners

Volume 1 Third Edition

By Sheri Wood
www.whiterobindesigns.com



A Division of Laser Excel™
N6323 Berlin Road
Green Lake, WI 54941

Welcome to the World of Nautilus Baseline Tools

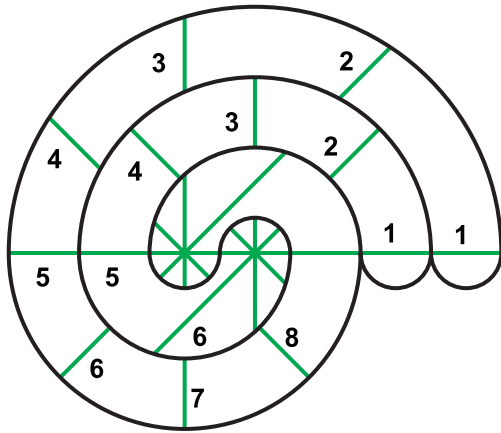

Nautilus Feather Tool Set
3" and 4"
QR-NFT

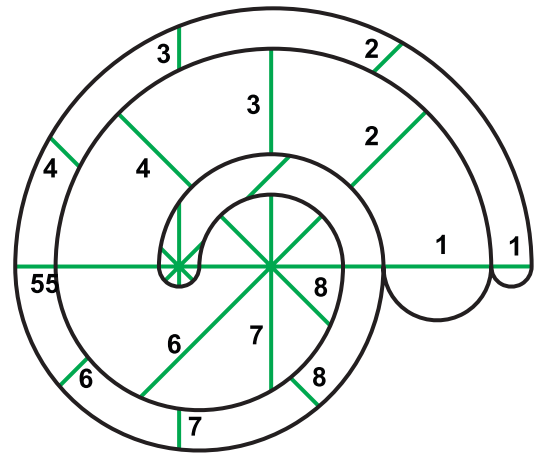

Nautilus Chunky Feather Tool Set
6" and 7"
QR-NCT

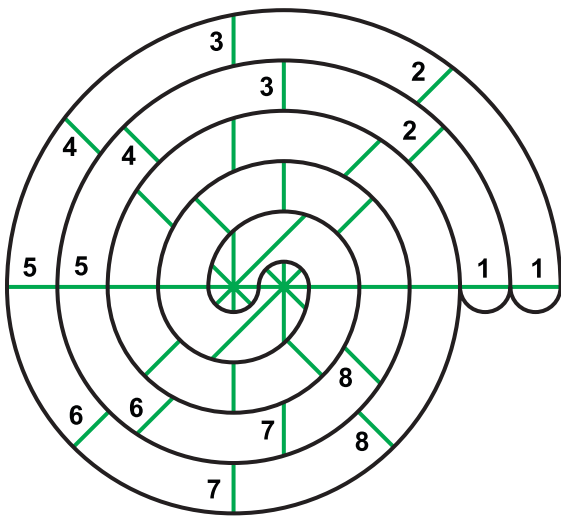

Nautilus Spiral Tool Set
6" and 7"
QR-NST

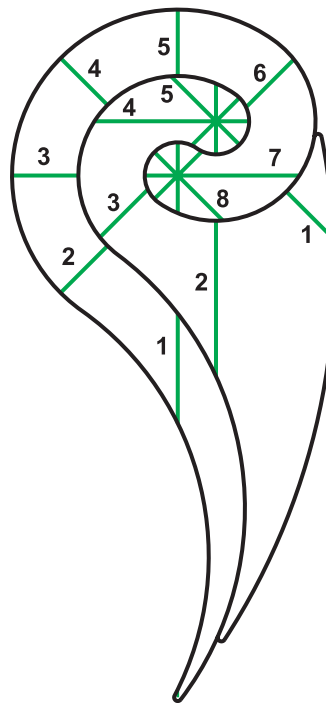

Nautilus Baby Long Tail
QR-NBLT

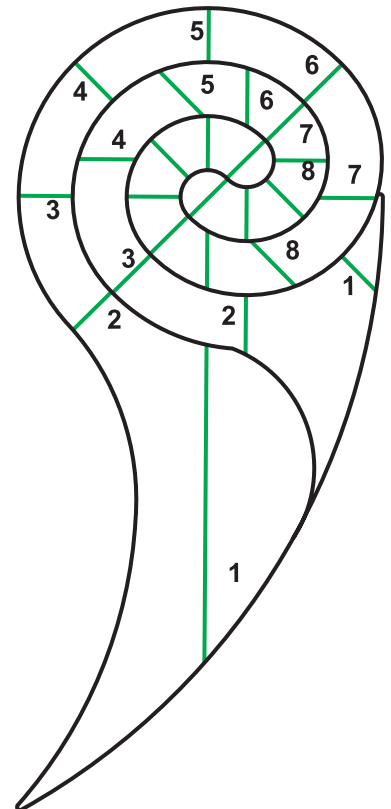

Nautilus Long Tail
QR-NLT

©2008 Sheri Wood, White Robin Designs www.whiterobindesigns.com

Purchase of this booklet grants you permission to copy the baseline practice sheets for your personal use.

No other part of this book may be reproduced by any means without written permission from White Robin Designs, Box 71, Altona, IL 61414.

GENERAL DIRECTIONS

The NEW Nautilus Baseline Tools will help you make baselines for many different borders, corners, and blocks. Simply draw or stitch a baseline and embellish with feathers, spirals, leaves or anything you can imagine. Whether you are quilting on a longarm, midarm, shortarm, or domestic machine or hand you can use the Nautilus Baseline Tools to create designs that are perfect for your quilt.

When using the Nautilus Baseline Tools for quilting by hand or by domestic machine, use a template tester* to draw the baseline on the quilt or on paper to transfer to the quilt by your preferred methods. You can use a mechanical pencil with the regular template tester. The new template tester with the larger diameter center hole can be used with the blue water soluble markers for fabrics.

When using the Nautilus Baseline Tools with a quilting machine; whether longarm, midarm, or shortarm, use the extended base suggested for your machine. The appropriate template foot for your machine is required. Check with your quilting machine dealer if you have any questions about your machine's accessories.

The Nautilus Baseline Tools are easy and versatile tools to work with, but as with any new tool or technique, practice is encouraged before you start quilting. As always patterns are only suggestions, and trying new designs by drawing them is encouraged.

If you have trouble with the tools slipping while you are quilting, try using the Grip Stop Dots (available from Quilter's Rule) or 505 Temporary Adhesive Spray.

Directions for the designs can be used with any size of the Nautilus Spiral Tools.

*Template testers are available from Quilter's Rule free of charge. Send a self-addressed stamped envelope to:

Quilter's Rule
Template Tester/Nautilus Tools
N6323 Berlin Road
Green Lake, WI 54941

Or look for us at one of the many shows we attend throughout the United States. Check our web site www.quiltersrule.com for show calendar.

The Nautilus Spiral Tool is etched with registration lines that divide the tool into 8 sections. The sections are numbered starting from the open or tail end. The registration lines are used to help you keep the baseline even. The baseline is your stitching line.

General Terms:

- Registration lines - Etched lines on the tool
- Baseline - Stitched lines
- Center guide line - Marked lines on the quilt

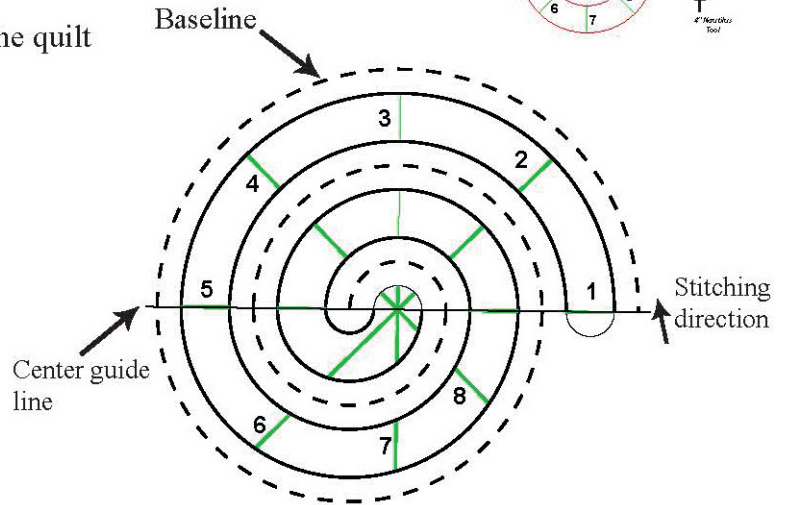
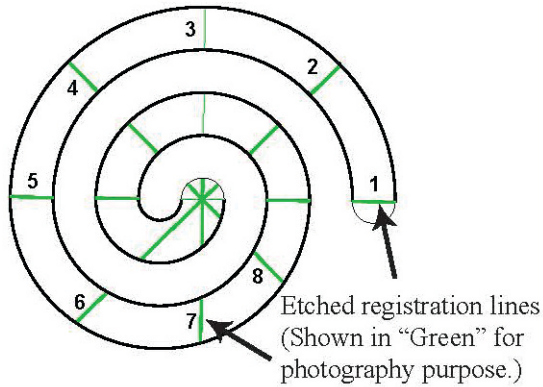
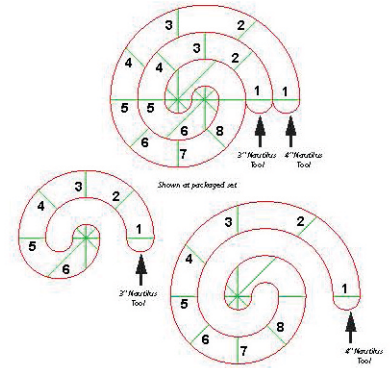

For borders, mark a center guide line on the lengthwise center of the border with an appropriate marking tool. My favorites include Hancy’s Ultimate Iron Off Chalk Powder (that I put into a chalk pen – the kind that you can refill and has a wheel on the bottom) or a blue water soluble marker. **ALWAYS** test your choice of marking methods. Mark a widthwise center guide line at the center of each border and the diagonal of each corner. For blocks and other spaces, mark whatever lines that are needed to keep the baselines even.

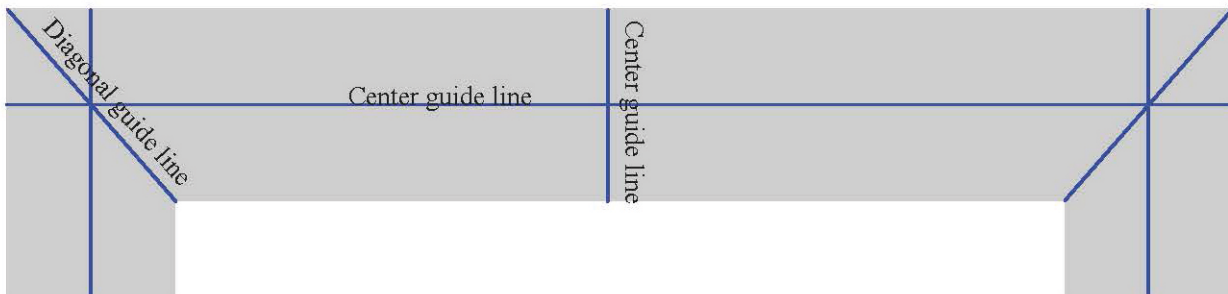

1 and 5 Straight Border

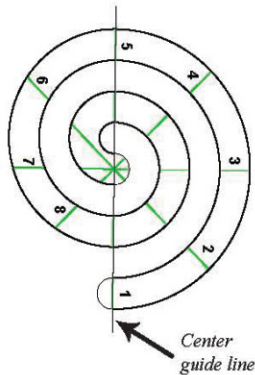

1. Place the Nautilus Spiral Tool on the lengthwise center guide line mark of the border. Position the #1 and #5 registration lines of the tool on the center guide line.

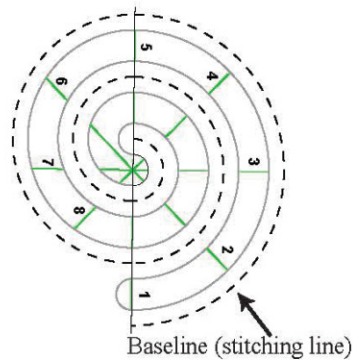

2. Bring up your bobbin thread and anchor your stitching line. Begin sewing around the outside edge of the Nautilus Spiral Tool, adjusting your hand position as necessary, until you stitch to the center of the tool.

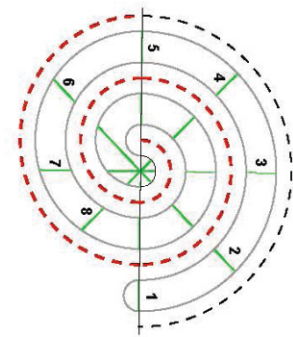

3. Backtrack your stitching line until you reach the top of the tool (#5 registration line) and the center guide line of the border.

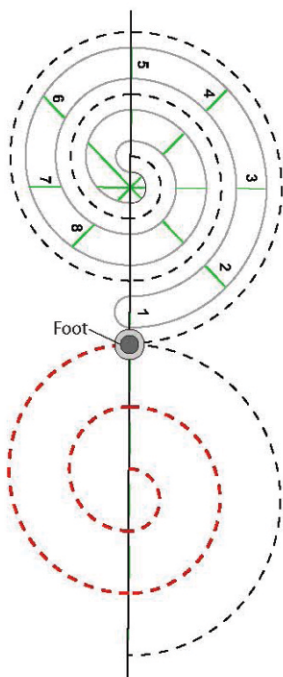

4. With needle down on the center guide line, move the Nautilus Spiral Tool so #1 registration line butts up against the foot. Keep the Nautilus Spiral Tool facing the same direction as before and begin stitching around the tool until you reach the center.

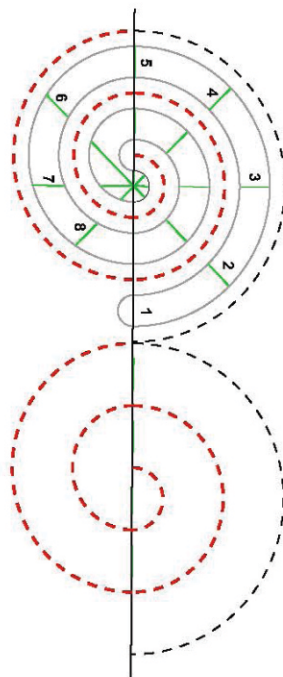

5. Backtrack your stitching out to the top center (#5).

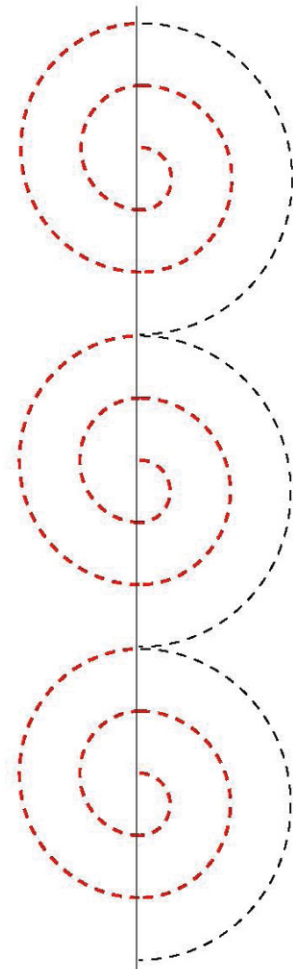

6. Continue as far as you need to complete your border or until you need to reposition the quilt.

7. Embellish if desired.

The RED stitching line indicates "Backtrack" stitching

1 and 5 Alternating Border

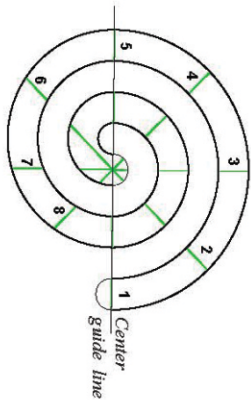

1. Place the Nautilus Spiral Tool on the lengthwise center guide line mark of the border. Position the #1 and #5 registration lines of the tool on the center guide line.

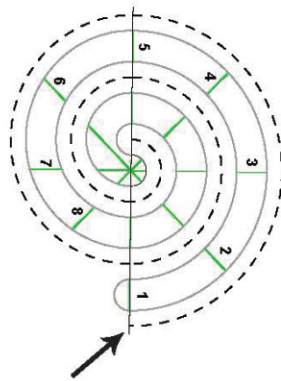

2. Bring up your bobbin thread and anchor your stitching line. Begin sewing around the outside edge of the Nautilus Spiral Tool, adjusting your hand position as necessary, until you stitch to the center of the tool.

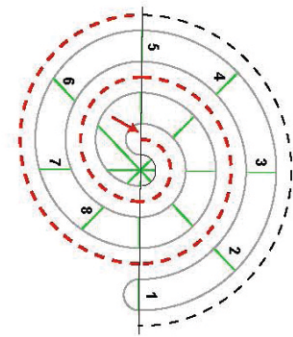

3. Backtrack your stitching line until you reach the top of the tool (#5 registration line) and the center guide line of the border.

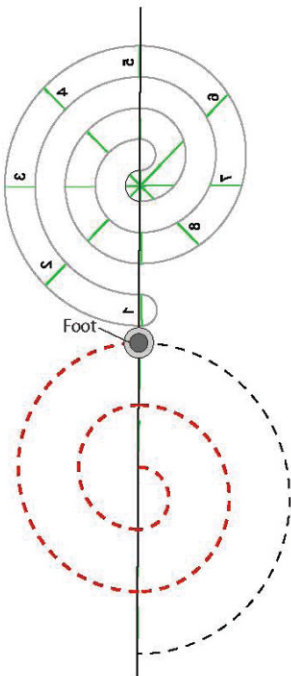

4. Flip the Nautilus Spiral Tool over so it faces the opposite direction as before and #1 registration line is at the foot.

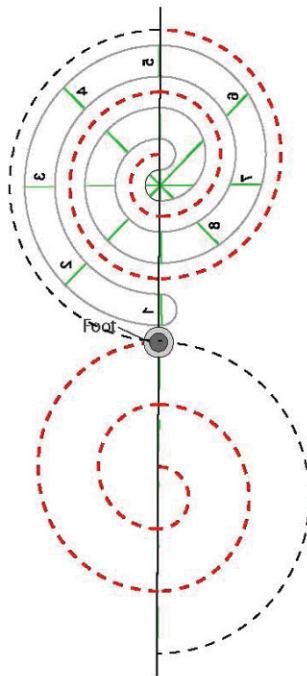

5. Begin stitching around the tool until you reach the center. Backtrack out to registration line #5.

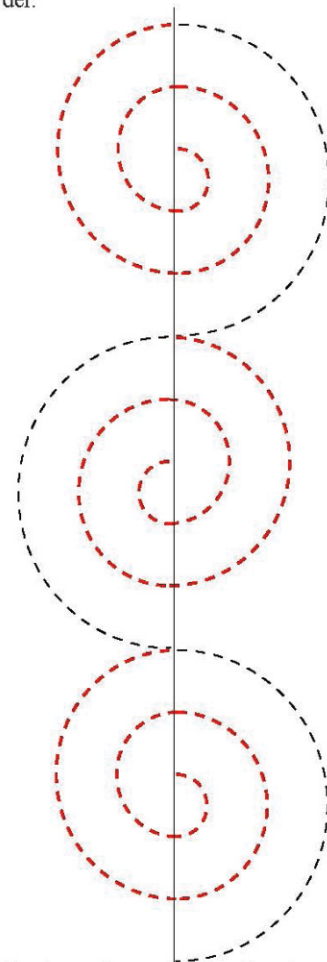

6. Continue alternating the direction of the tool, stitching until you finish your border or need to reposition the quilt.

7. Embellish if desired.

The RED stitching line indicates "Backtrack" stitching

Embellishing Ideas

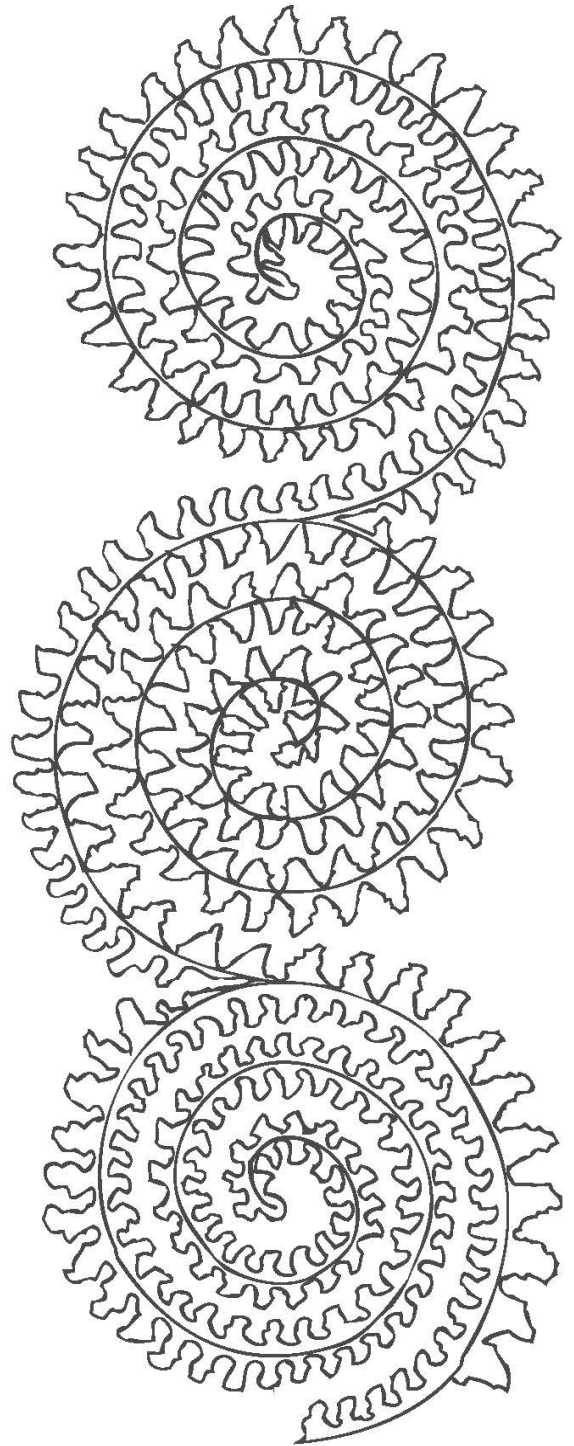

1 and 3 Alternating Border

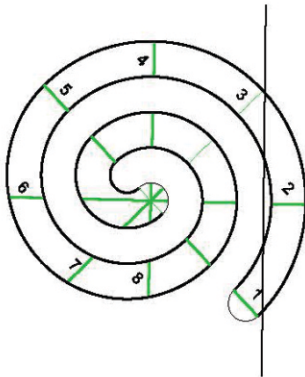

1. Place the Nautilus Spiral Tool on the lengthwise center guide line of the border. Position the #1 and #3 (at outside edge of tool) registration lines of the tool on the center guide line.

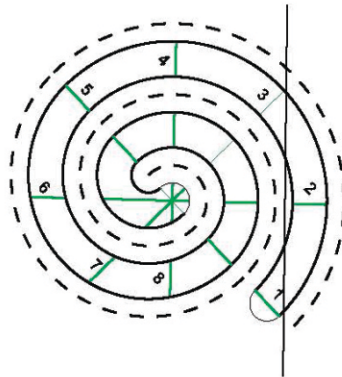

2. Bring up your bobbin thread and anchor your stitching line. Begin sewing around the outside edge of the Nautilus Spiral Tool, adjusting your hand position as necessary until you stitch to the center of the tool.

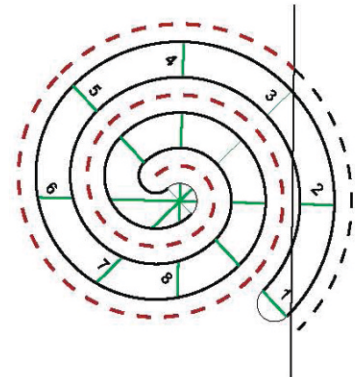

3. Backtrack your stitching line until you reach the top of tool (#3 registration line of the tool) and the center guide line of the border.

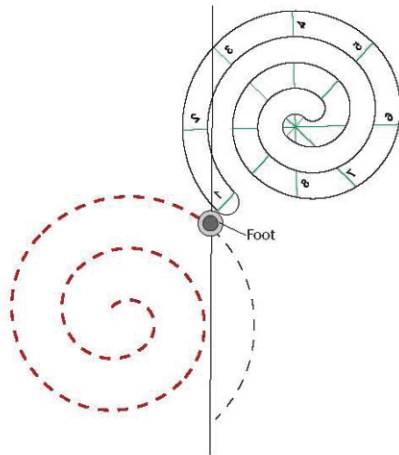

4. Flip and move the Nautilus Spiral Tool so #1 registration line is at the foot and it faces the opposite direction as before.

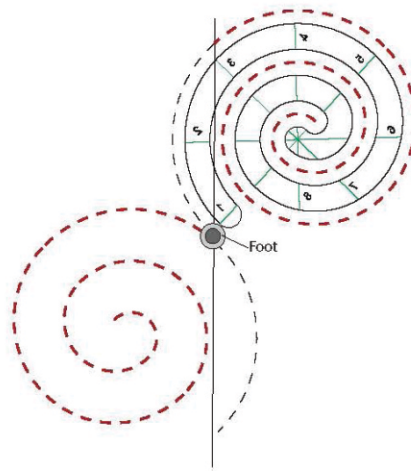

5. Stitch around outside edge of the tool until you reach the center. Backtrack out to the #3 registration line.

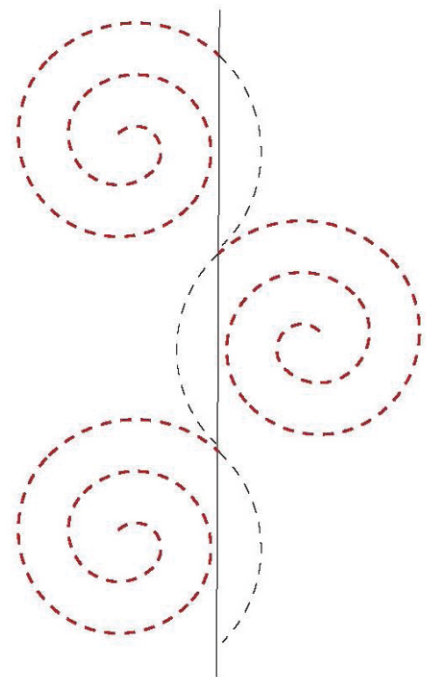

6. Continue stitching, alternating directions of the Nautilus Spiral Tool each time until you need to reposition the quilt or complete the border.

7. Embellish if desired.

The RED stitching line indicates "Backtrack" stitching

Embellishing Ideas

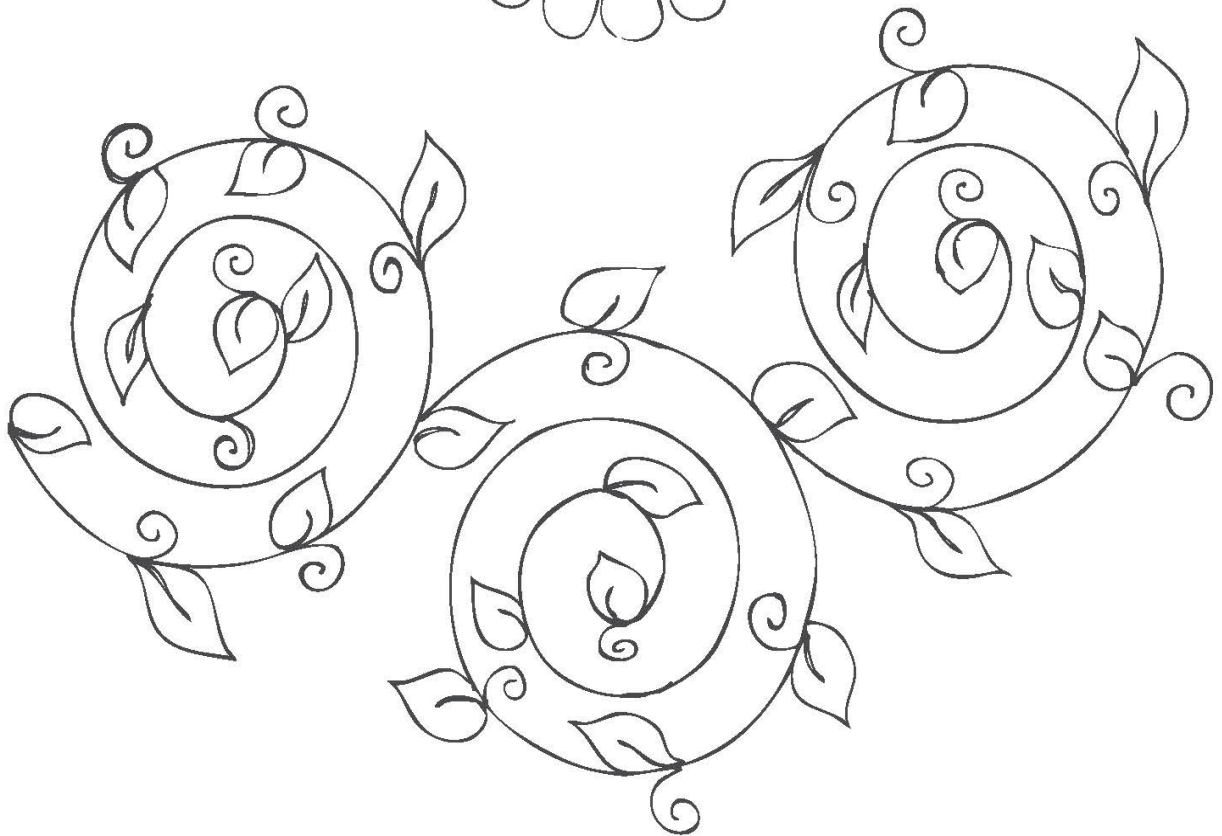
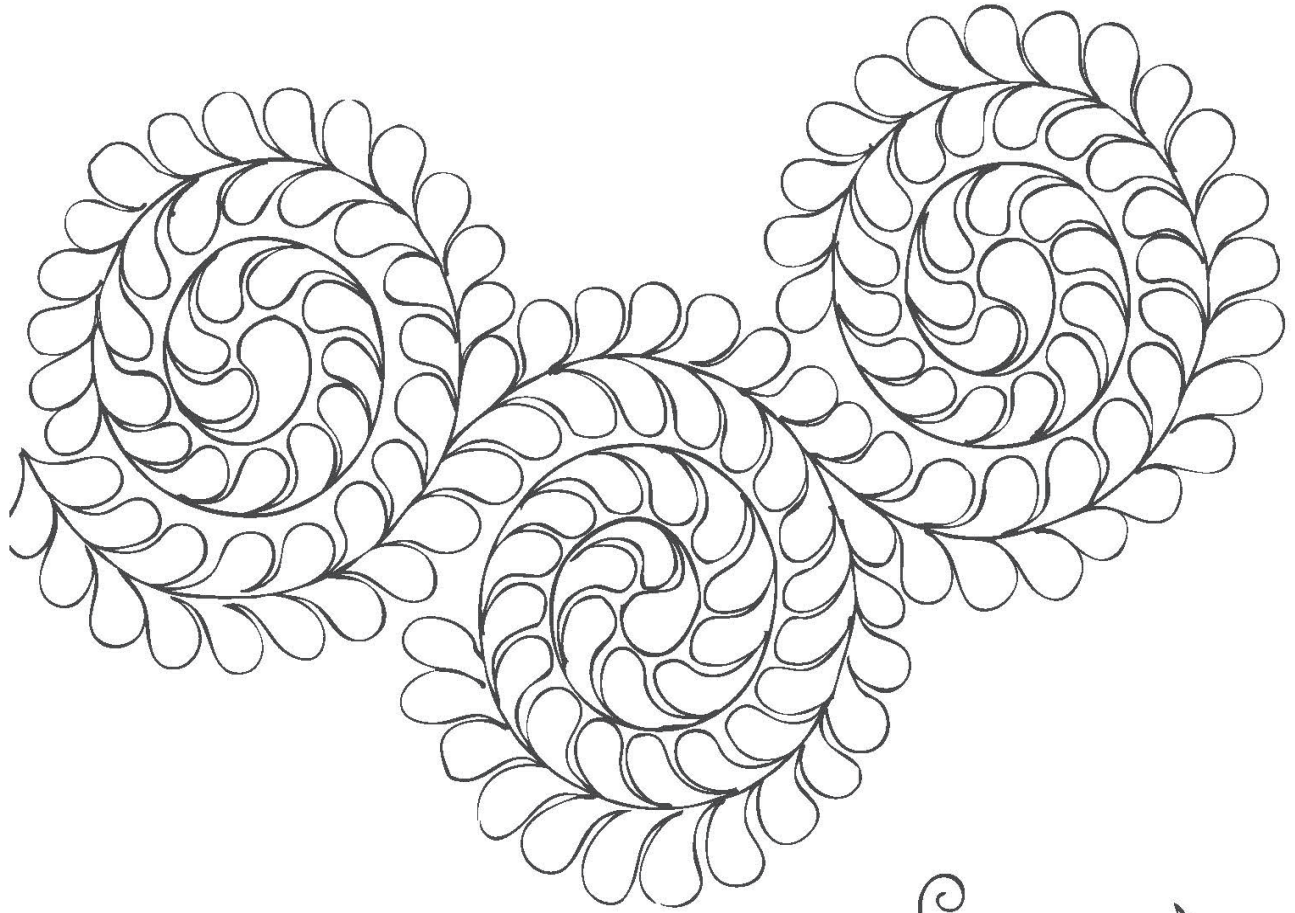

Corner #1

This is the easiest corner to make and can be used with any of the border designs. When you get to a corner, continue the design around the corner, adjusting the direction to fit the border. Embellish as you desire.

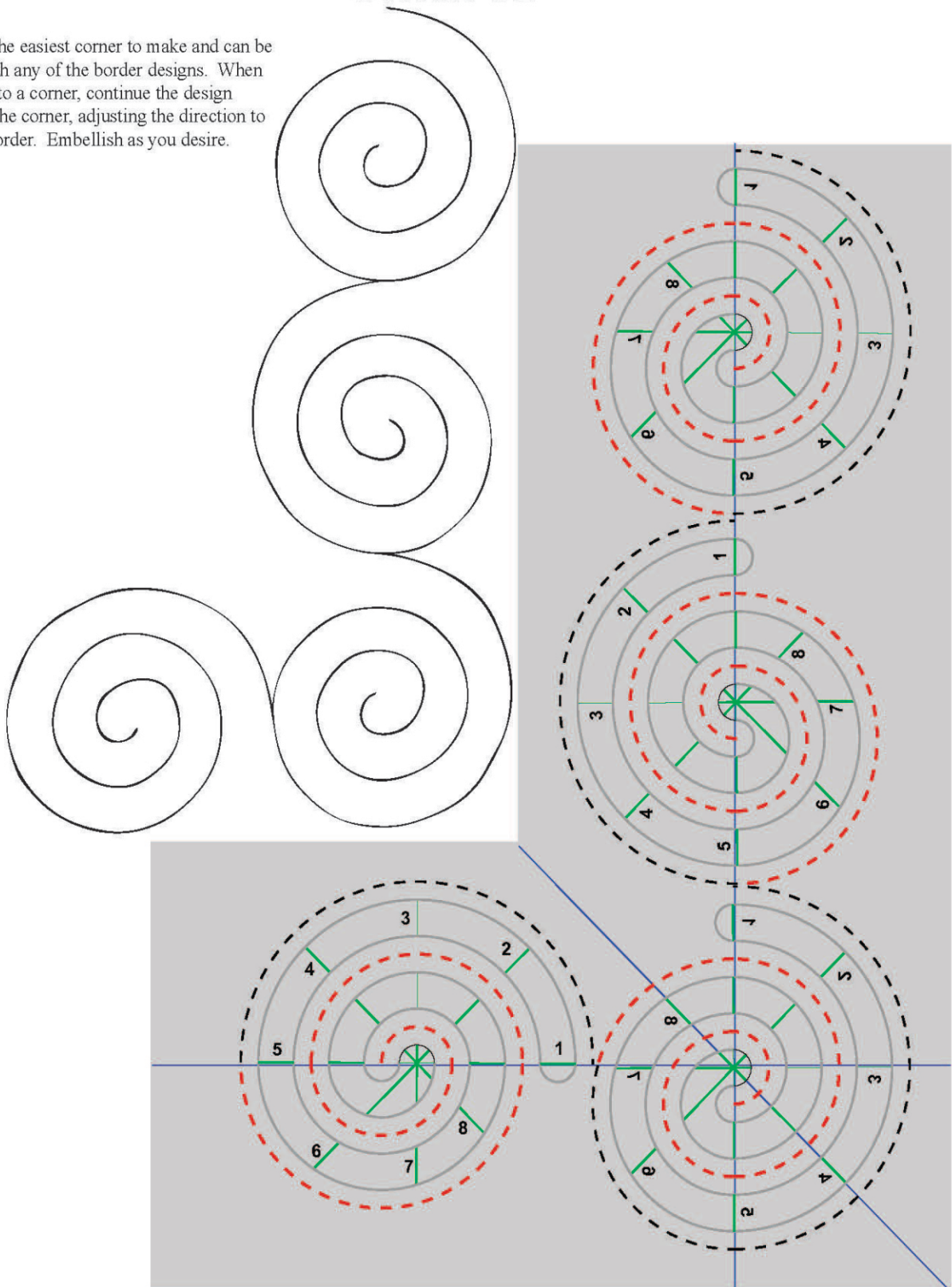

The RED stitching line indicates "Backtrack" stitching

Corner #2

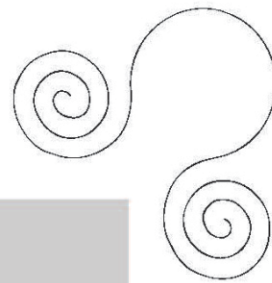
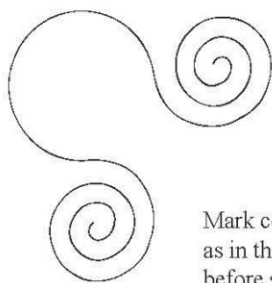

Mark corners and center of border as in the "General Directions" before stitching this corner.

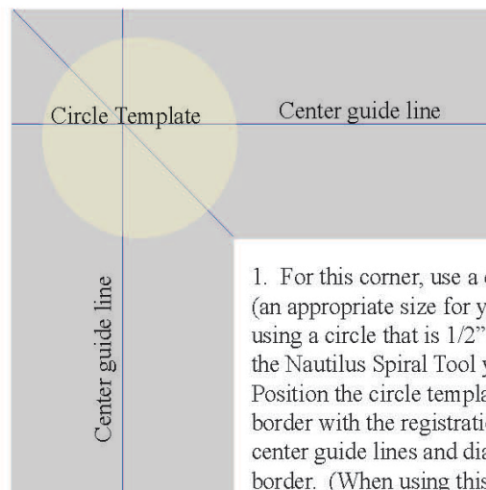
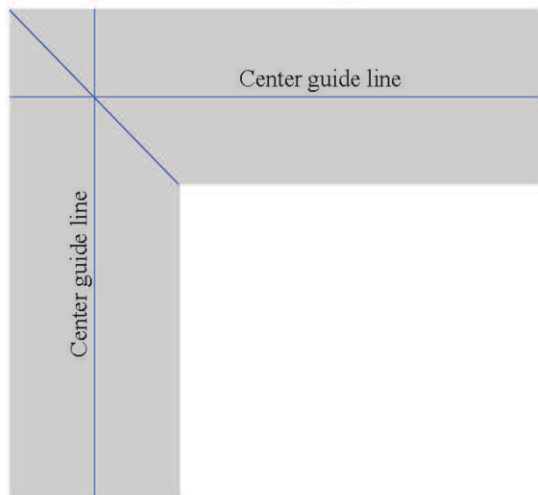

1. For this corner, use a circle template (an appropriate size for your border). Try using a circle that is 1/2" to 1" larger than the Nautilus Spiral Tool you are using. Position the circle template in corner of border with the registration lines on the center guide lines and diagonal line of border. (When using this corner start the border in the corner and work to the centers of each border or the opposite corner of the quilt.)

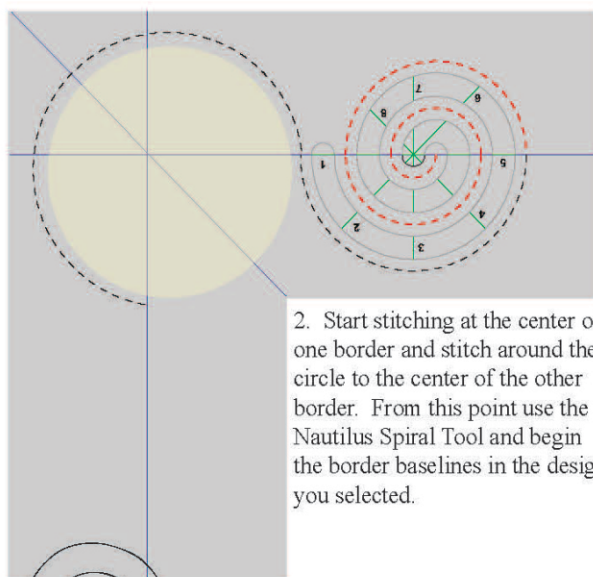

2. Start stitching at the center of one border and stitch around the circle to the center of the other border. From this point use the Nautilus Spiral Tool and begin the border baselines in the design you selected.

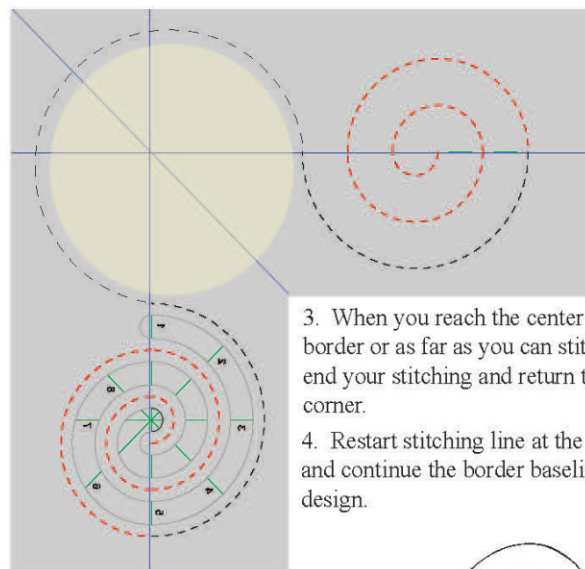

3. When you reach the center of the border or as far as you can stitch, end your stitching and return to the corner.
4. Restart stitching line at the corner and continue the border baseline design.

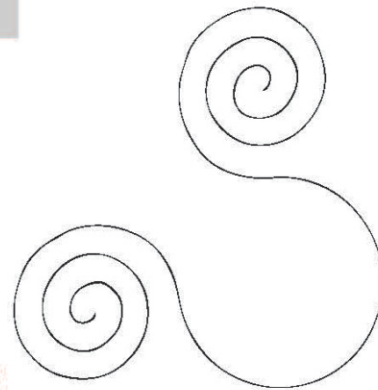
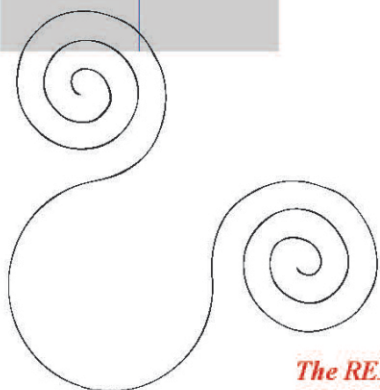

The RED stitching line indicates "Backtrack" stitching

Corner #3

For this corner design you will start your border baseline at the corner and work to the center of each border. Mark center of border and corners as in the “General Directions”.

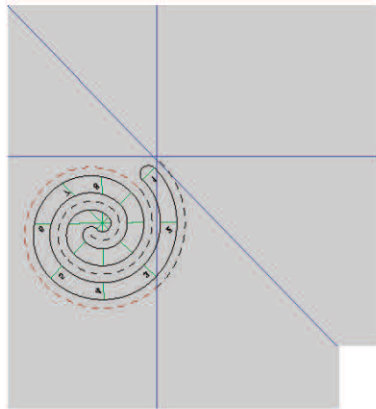
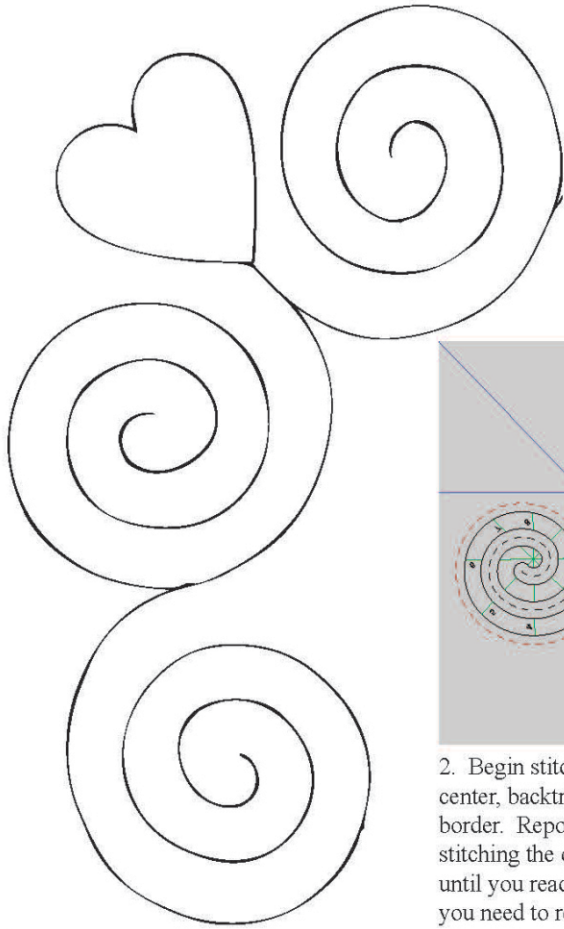

2. Begin stitching around the tool to center, backtrack to center guide line of border. Reposition the tool and continue stitching the design you have selected, until you reach the center of the border or you need to reposition the quilt.

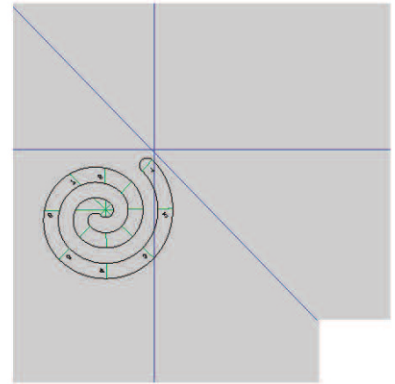
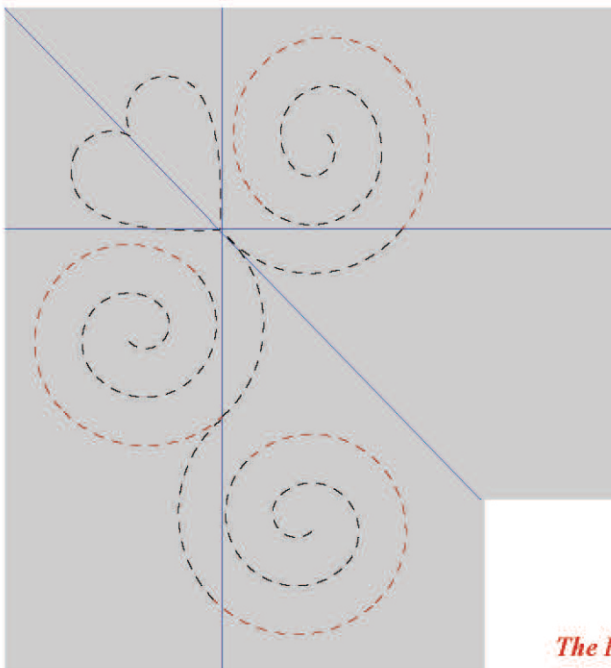

1. Place the Nautilus Spiral Tool at the corner with #1 registration line on the point where the center guide line and diagonal lines of border intersect. Use #2, 3, 4, or 5 for other point depending on how open you want the corner to be.

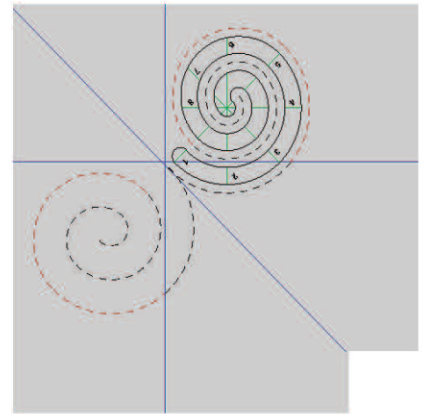

3. Restart stitching line at the corner and continue the baseline design on other. Embellish the corner as desire.

The RED stitching line indicates “Backtrack” stitching

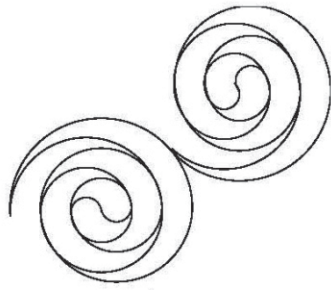

Twisted Ribbon Border

The Twisted Ribbon Border makes a beautiful border. A Twisted Ribbon Border can be made by using the Nautilus Feather Tools, Nautilus Chunky Tools or Nautilus Spiral Tools. The instructions are the same for all three tools, but each will have its own unique look and feel. This border design is stitched with the Nautilus Spiral Tools.

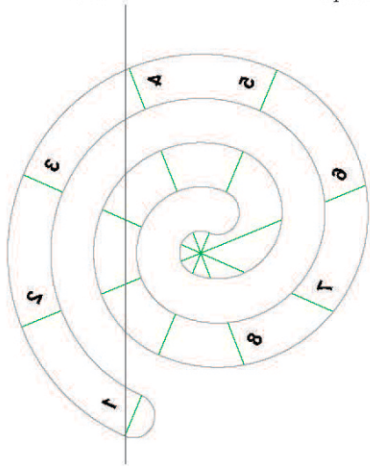
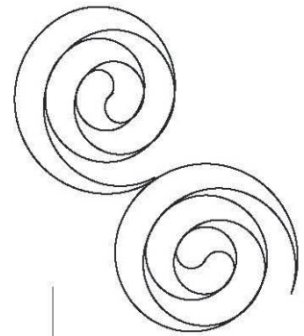

1. Place the smaller tool with #1 and #4 registration lines on the lengthwise center guide line of the border. (This also works using #1 and #3 registration lines.)

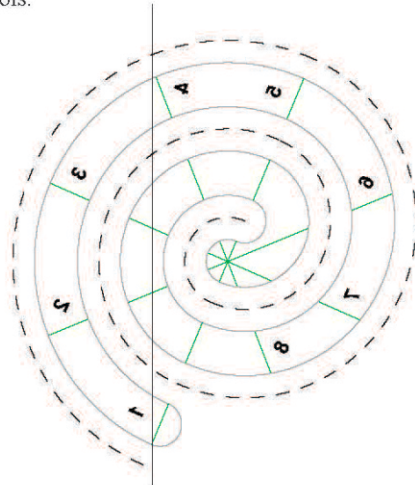

2. Bring up bobbin thread and anchor stitching line. Stitch around the outside edge of tool to the center.

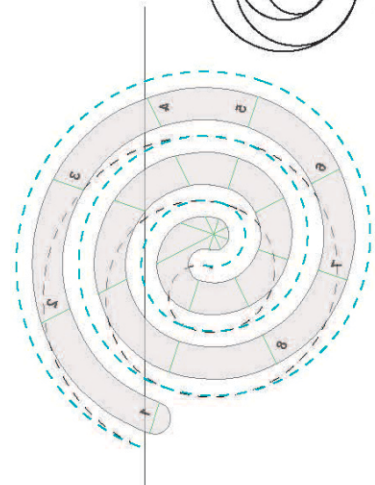

3. Drop needle, stop the machine and remove the smaller tool. Place the larger tool so the needle is at the center of the tool and #1 registration line is on the center guide line at bottom. Stitch out to #1 of the tool.

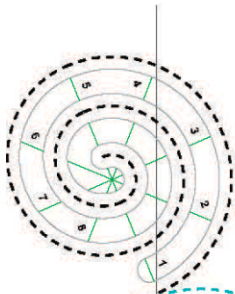

4. Backtrack the stitching around the outside up to center guide line on the border. Place the smaller tool with #1 at bottom and facing the opposite way as before. Stitch to center of the tool.

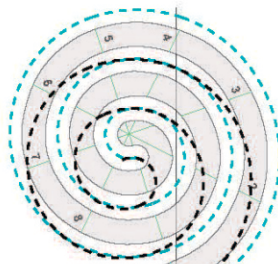

5. Drop the needle and stop the machine. Remove smaller tool and place the larger tool in position and stitch back to bottom. Backtrack stitching line to center line.

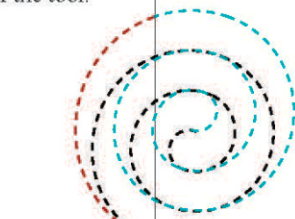

6. Continue stitching design until completing your border or you need to reposition the quilt.

The RED stitching line indicates "Backtrack" stitching

4 Spirals

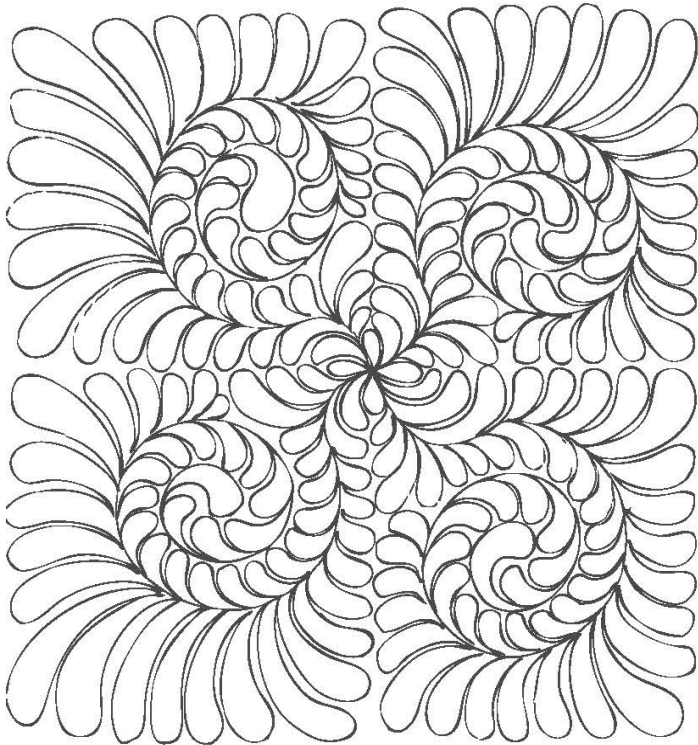
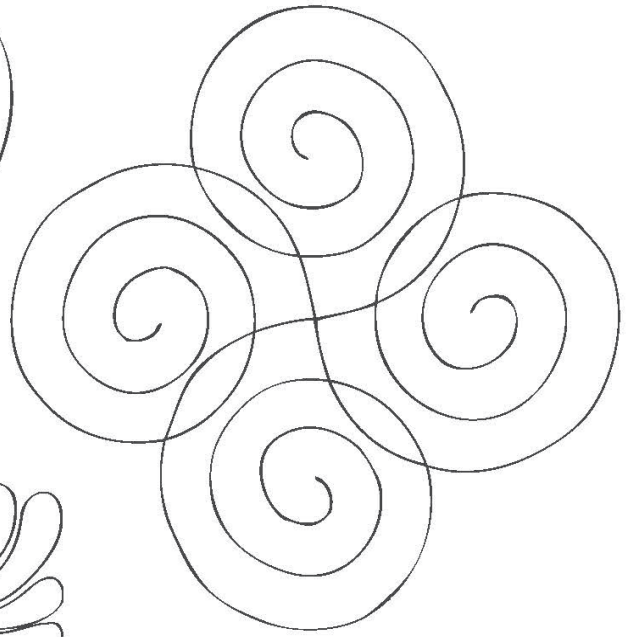
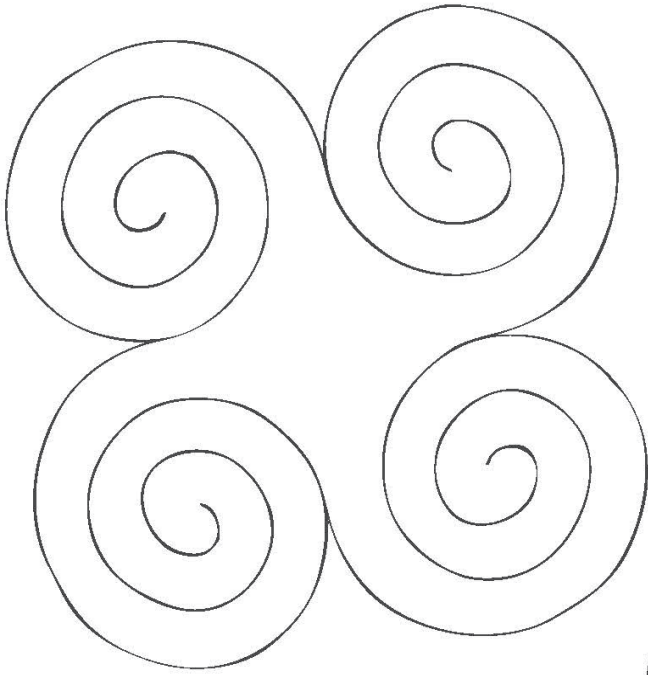

8 Spirals

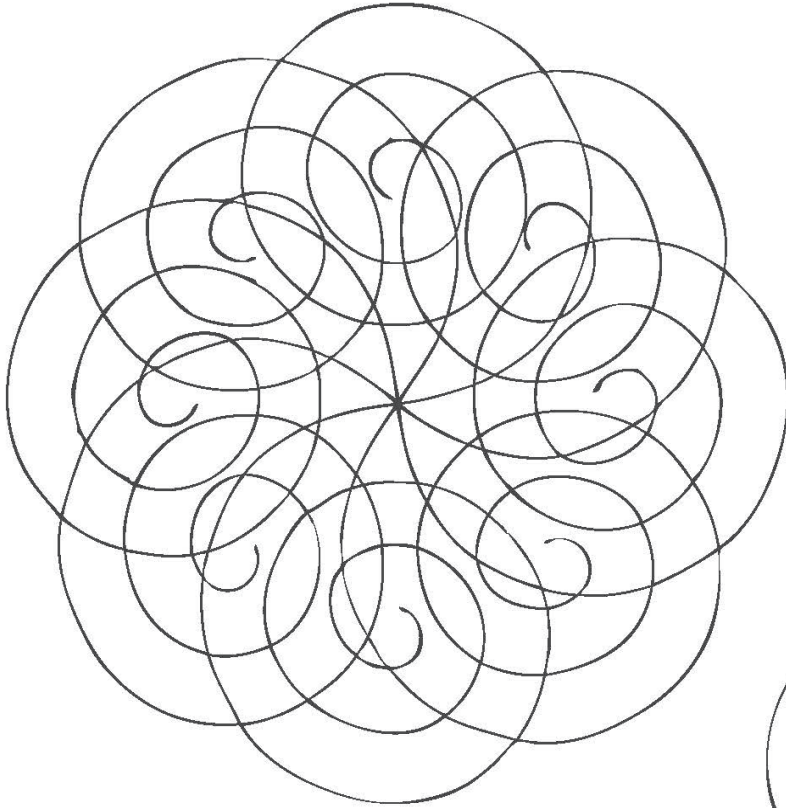

The Nautilus Baseline tools can be combined for more designs -
This combination is using the Nautilus Feather and Spiral Tools.

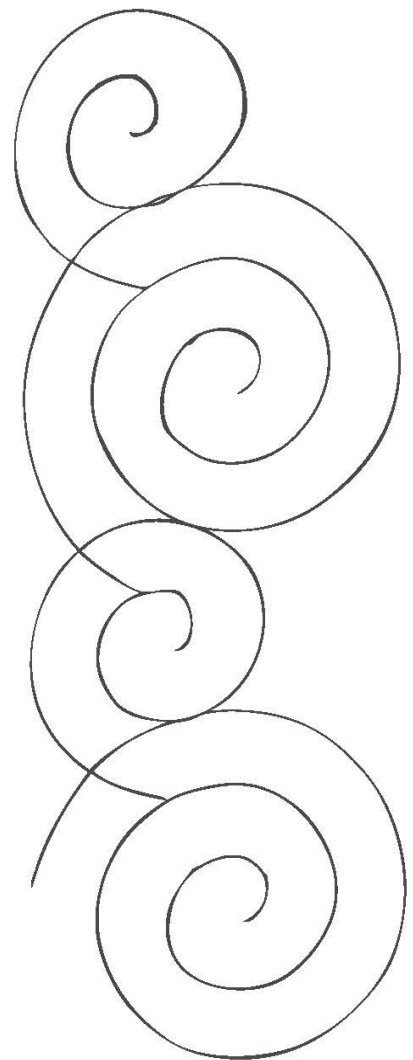
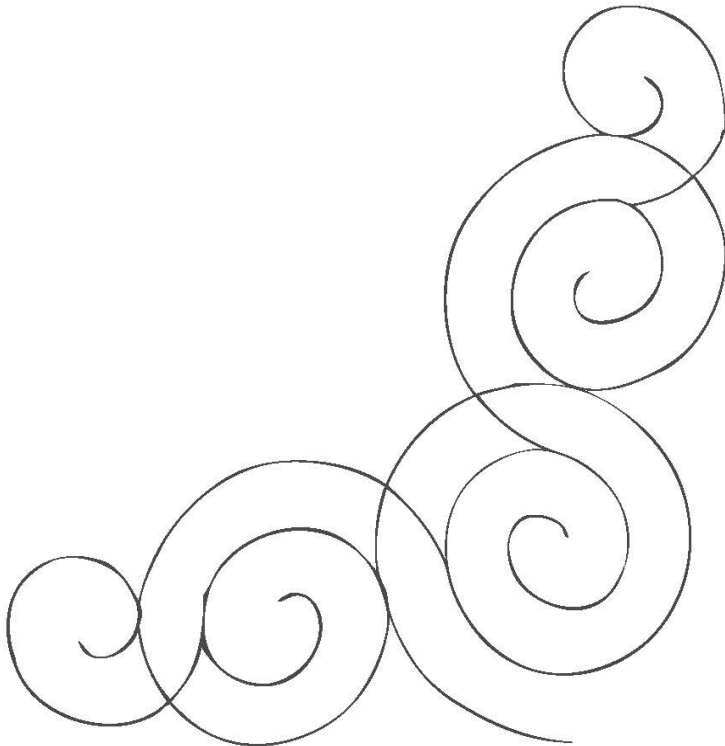

*Use corners as central medallion -
add smaller motif to center*

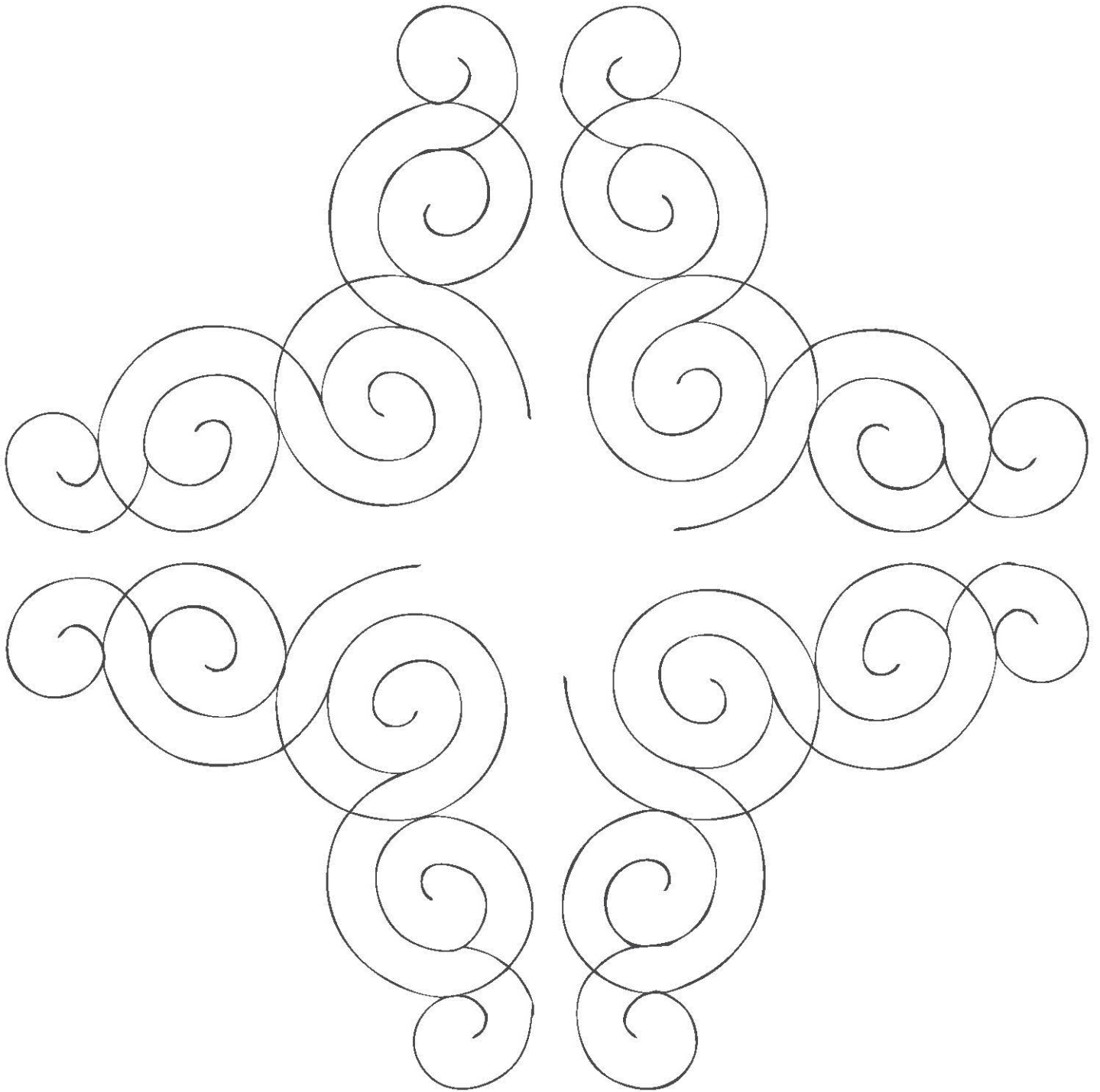

Use the corners as frame for smaller motif.

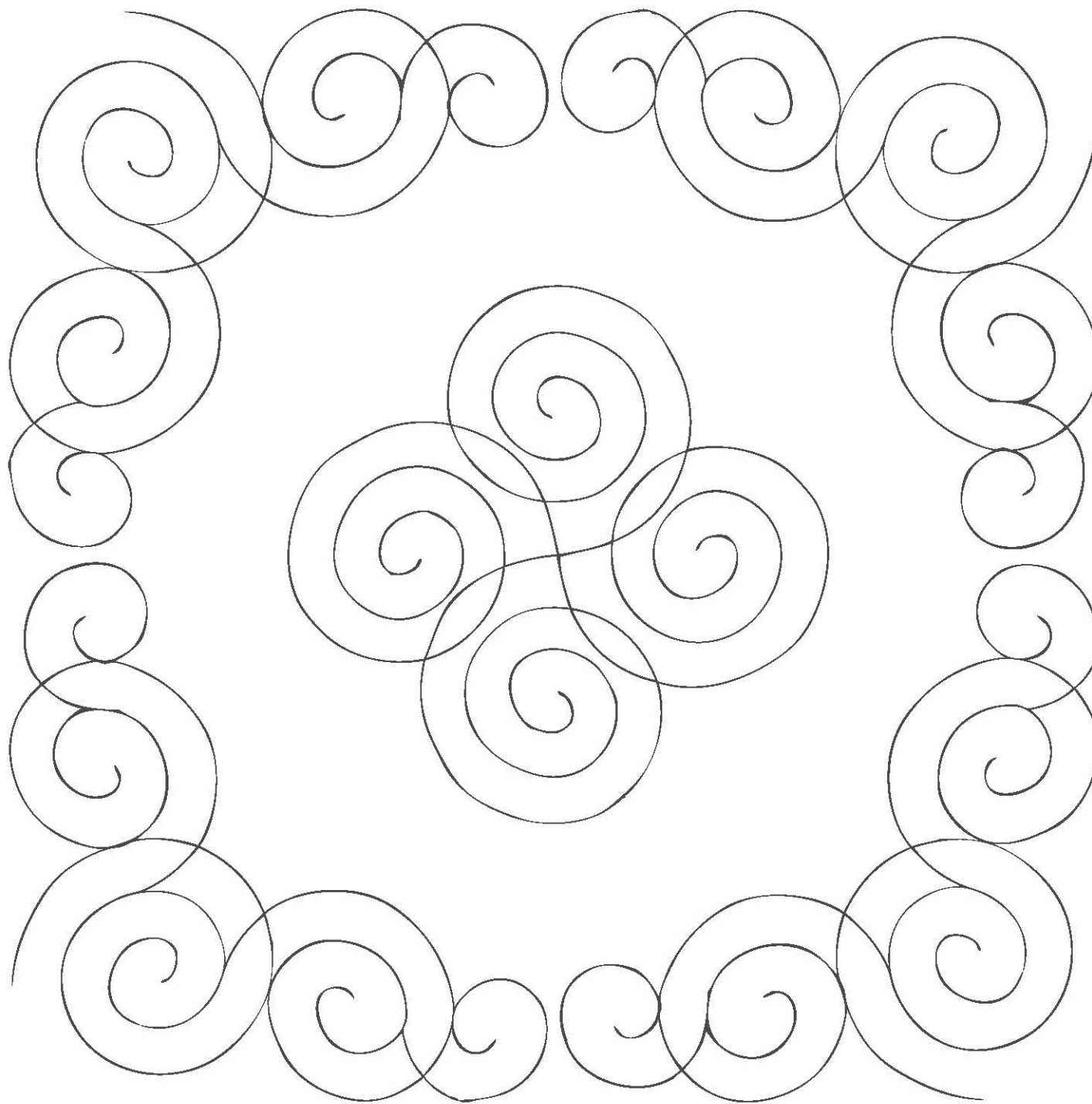

As you get more comfortable with the Nautilus Baseline Tools (Nautilus Feather, Feather Chunky, Spiral, and Delta), experiment with other arrangements, embellishments, and combinations of tools. Try adding them to templates you already own... add spiral on the points of a star or pinwheel. Stitch one inside a large paisley or on the end of the paisley. How about with hearts, or inside a square; the possibilities are limited only by your imagination.

Ideas and inspiration for designs are all around us. Many of the embellishment designs shown in the booklet have been inspired by nature and influenced by the quilts I've seen, classes I've attended, in architectural details or clip art books. Remember patterns are only suggestions! Through this booklet and the Nautilus Baseline Tools, I am happy to share with you designs I have been working with. I encourage you add your ideas to these and stitch designs as individual as you!

Thank you,

Sheri Wood

Sheri Wood has been machine quilting for over 30 years. She started working with the longarm machine in 2001, and runs the custom quilting service at The Village Smithy Quilt Shop in Bishop Hill, IL. In addition to quilting and developing tools and patterns for quilting; she offers workshops on using the tools and hand dyeing fabrics for quilting. She can be reached at White Robin Designs.

Explore the possibilities with these other Nautilus Baseline Tools

Nautilus Feather Tool Set - 3” and 4”
Nautilus Feather Chunky Tool Set - 6” and 7”
Nautilus Spiral Tool Set - 6” and 7”
Nautilus Long Tail Tool
Nautilus Baby Long Tail Tool

and more to follow

Additional copies of this booklet and Nautilus Baseline Tools are available from:

Quilter's Rule

N6323 Berlin Road
Green Lake, WI 54941
(800) 343-8671
www.quiltersrule.com

White Robin Designs

Box 71
Altona, IL 61414
(309) 299-8007
www.whiterobindesigns.com

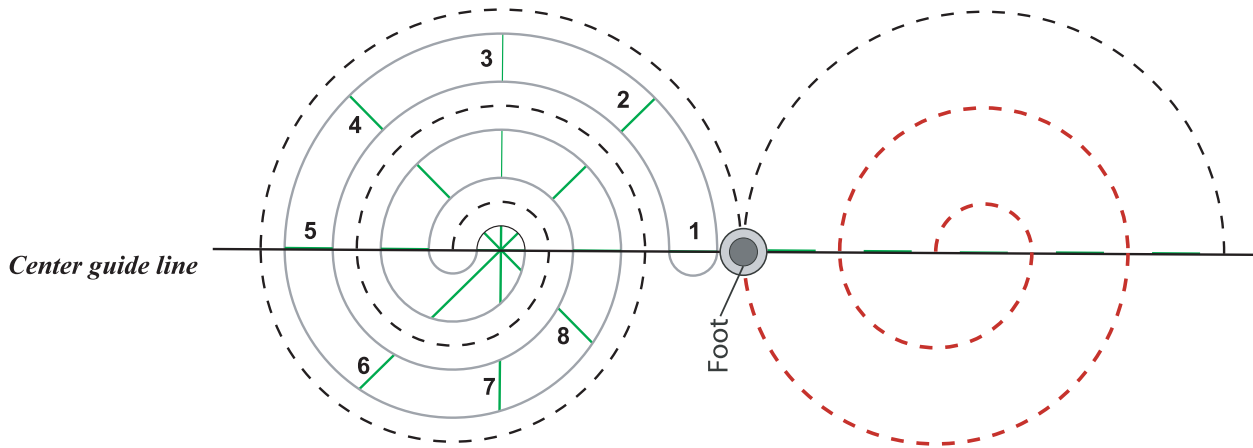

1 & 5 STRAIGHT BORDER

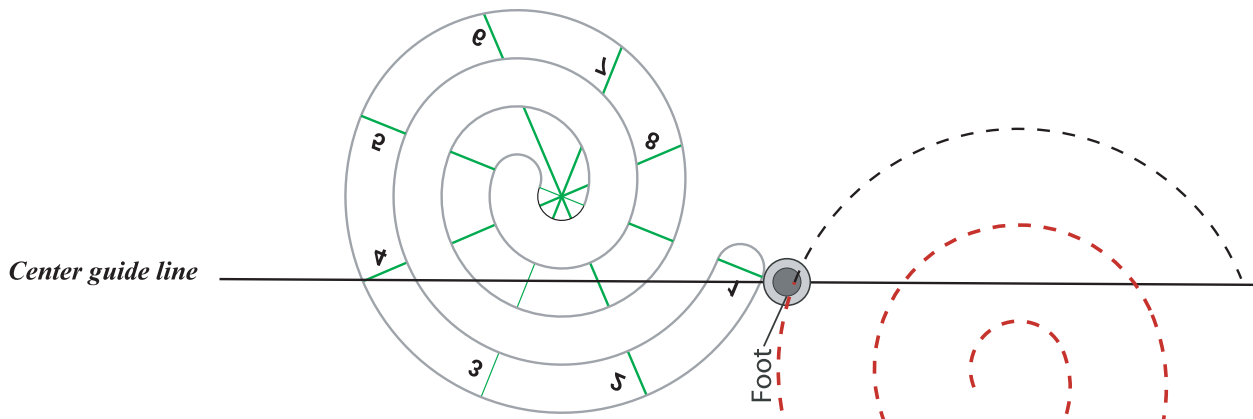

1 & 4 ALTERNATING BORDER

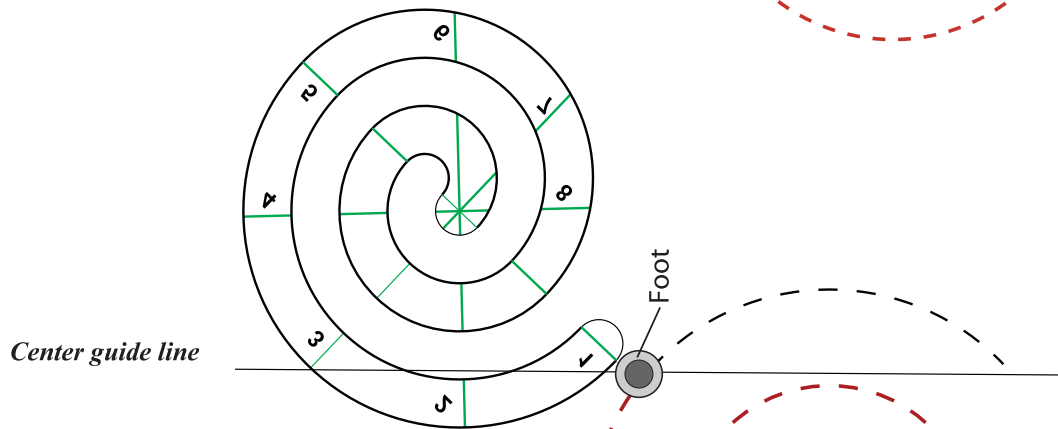

1 & 3 ALTERNATING BORDER