



We're more than just rulers!

Quilter's Rule®

A Division of Laser Excel
N6323 Berlin Road
Green Lake, WI 54941

Pointed Leaf/Oval Instructions

The Pointed Leaf/Ovals are multi size tools:

Available in 1/4" acrylic for Longarm and High Shank home machines (MQT-L01 & MQT-L02)

Available in 3/16" acrylic for Low Shank home machines (HMQT-L01 & HMQT-L02)

Available in 1/8" acrylic for Low Shank home machines (QR-L01 & QR-L02)

Quilter's Rule templates have EZ2C® Registration Lines and Fabric Gripping Action® on the bottom to help grip the fabric. These tools are designed for machine quilting (aka ruler quilting). Before you start, please make sure you have the correct foot on your machine to use templates (aka rulers). The dimensions of these tools are designed with the 1/2" round "ruler" foot in mind. This means the foot is 1/2" wide from outside edge to outside edge and it is "thick" or "tall" walled. If your foot is a different size, your stitch line will be slightly different than the stated measurement. If you have any questions about the correct ruler foot for your machine, please contact your dealer or the manufacturer of your machine.

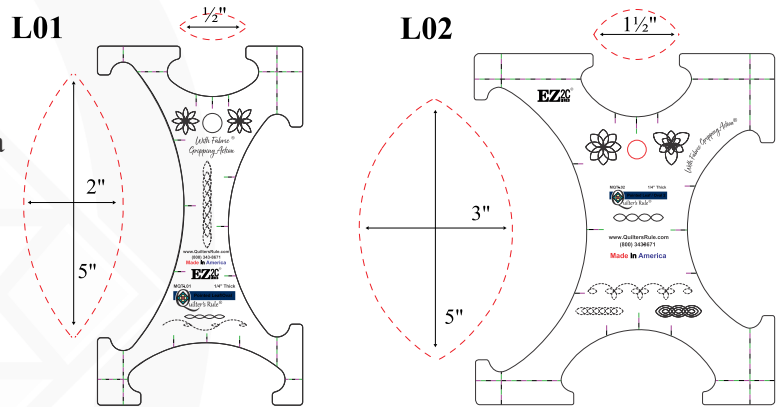

Create a Wave

1) Using either a line drawn (or chalked) on the quilt or a seam, you can create a simple wave. Use the EZ2C® Registration Lines in the tool to align the chosen size leaf/oval over the seam or line. Stitch from one end of the opening to the other. Needle Down.

2) Swing the tool around the foot (using the foot as a pivot point) until the EZ2C® Registration Lines are again lined up on the quilt. Stitch from one end of the opening to the other. Needle Down.

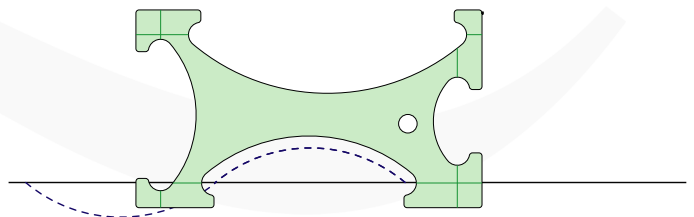
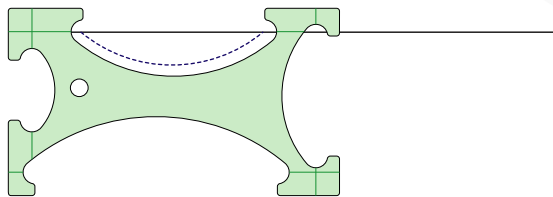

3) Repeat until wave is desired length.

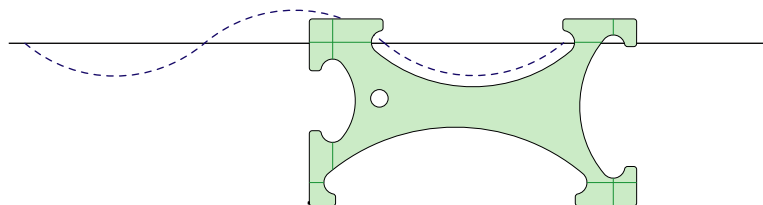

Create a Simple Chain

- 1) Start by creating a wave.
- 2) To create a chain, repeat the wave steps on the opposite side of your wave. (See illustration)

MQT-L01

Step 1

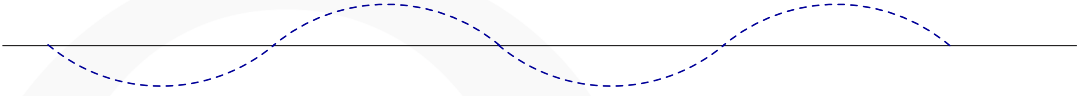

Step 2

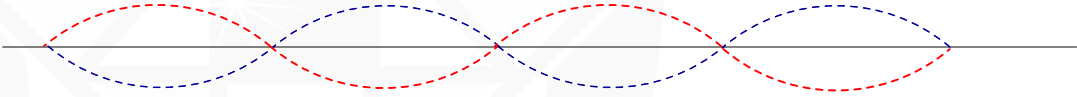
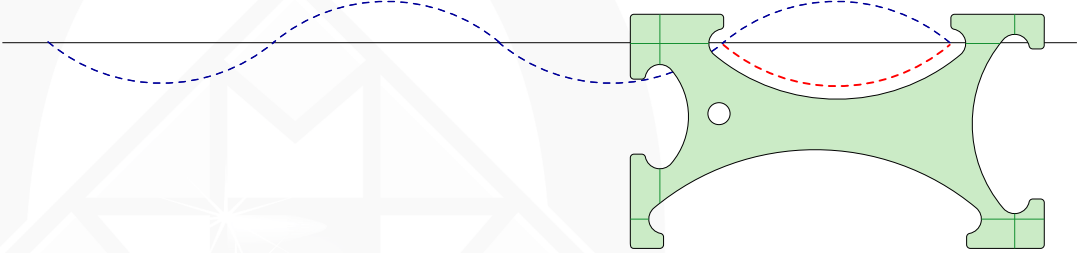

MQT-L02

Step 1

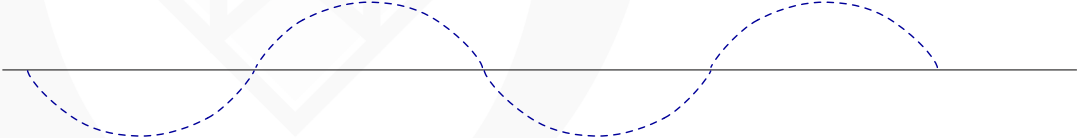

Step 2

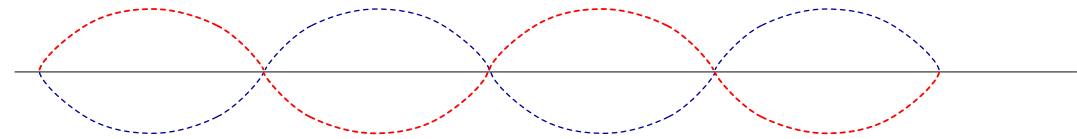
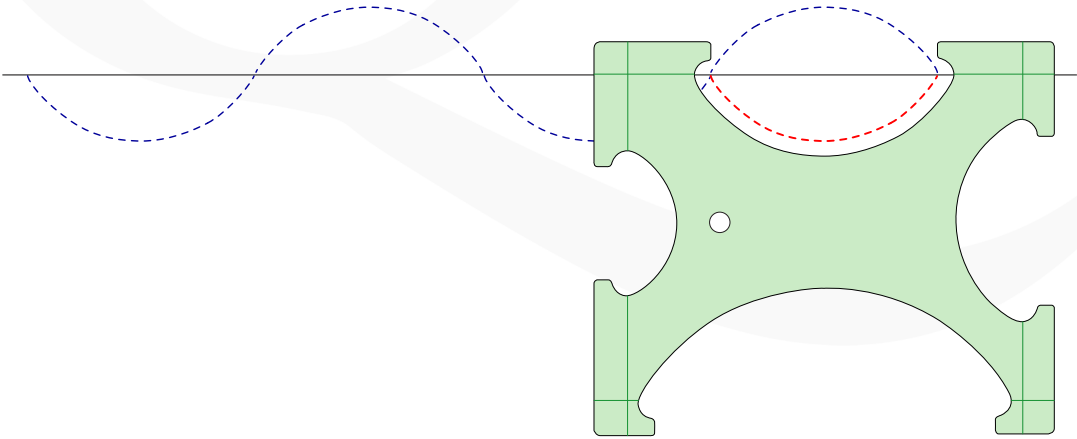

Multiple Sizes

Use multiple sizes of the tool to create a chain with multiple size links. (See illustration)

MQT-L01: Step 1

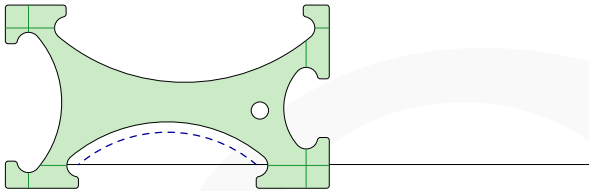

Step 2

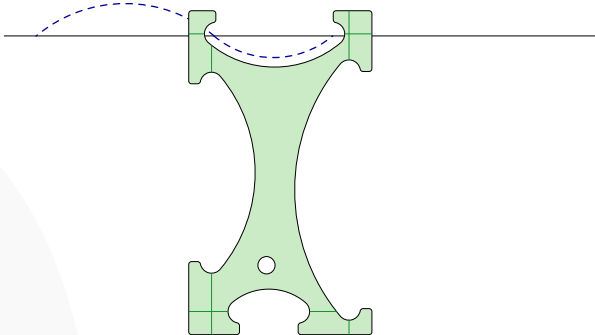

Step 3

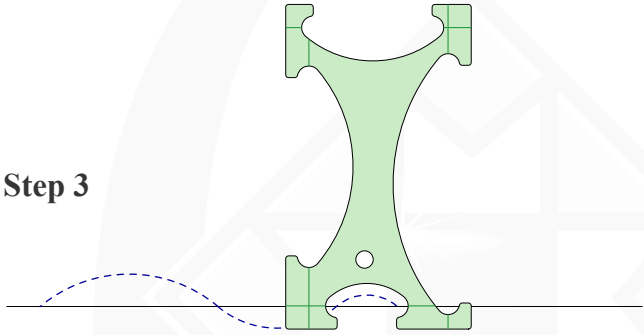

Step 4

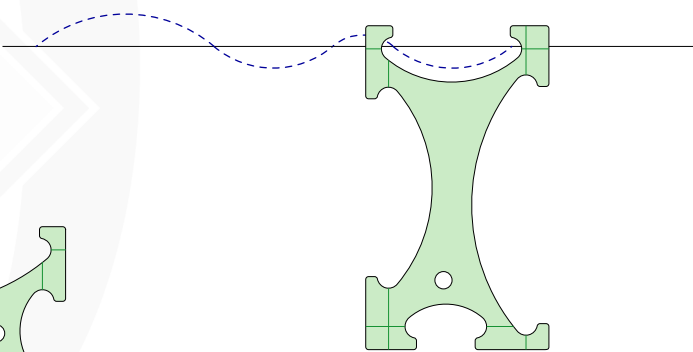

Step 5

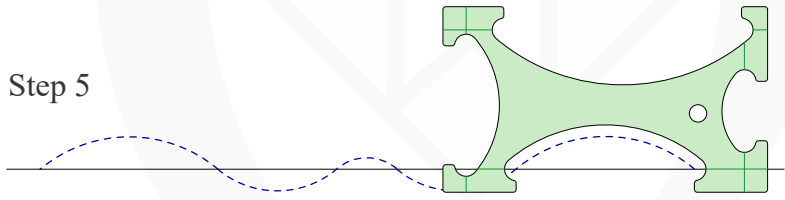

Step 6

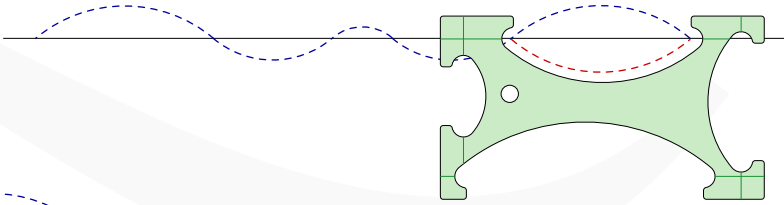

Step 7

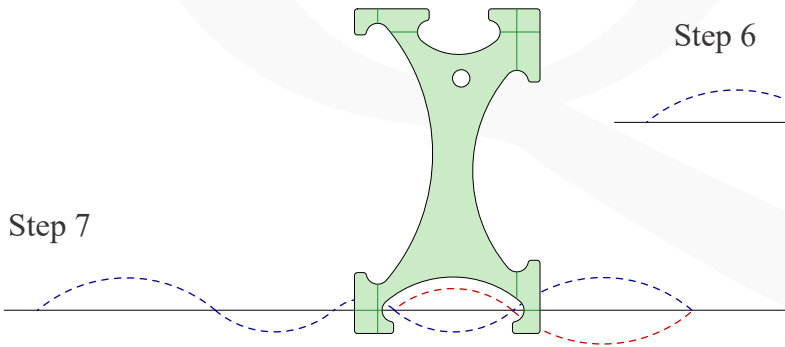

Step 8

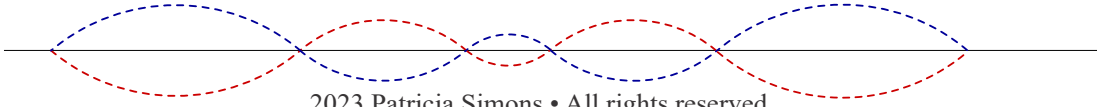
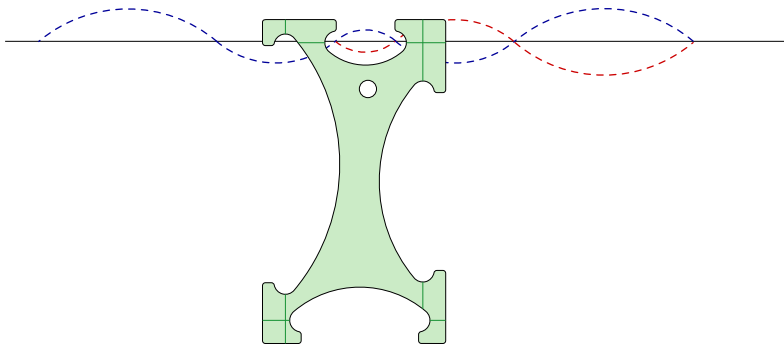

Multiple Sizes - Continued

MQT-L02: Step 1

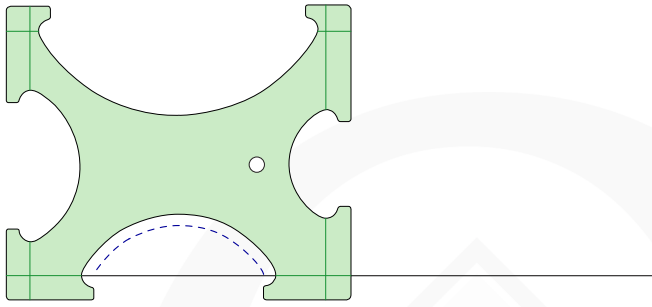

Step 2

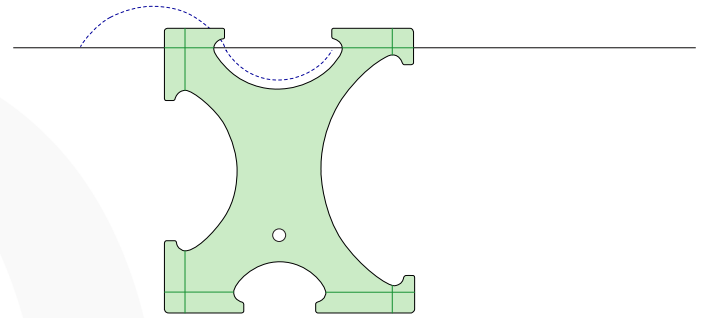

Step 3

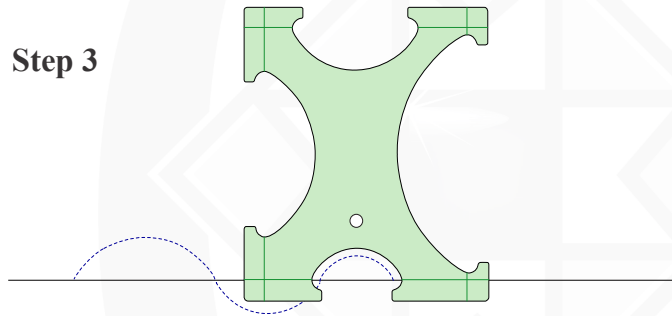

Step 4

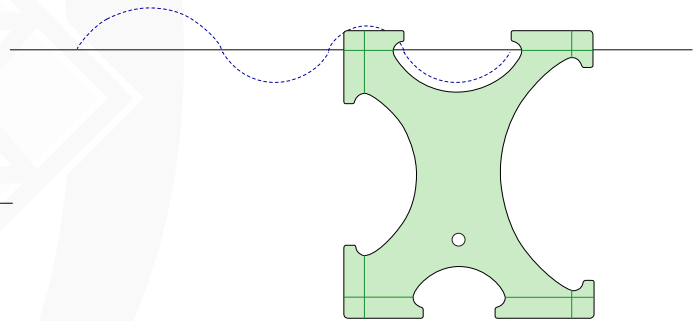

Step 5

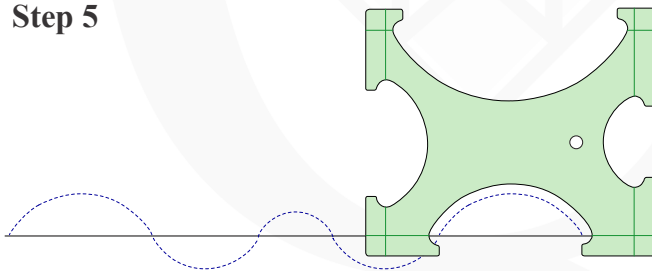

Step 6

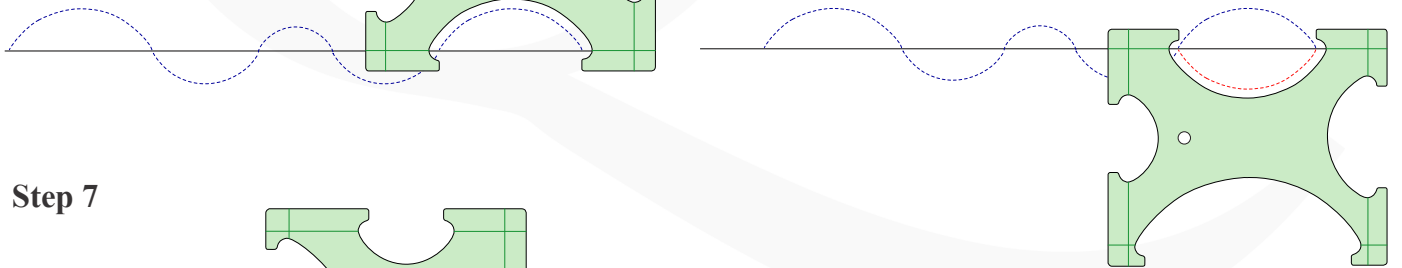

Step 7

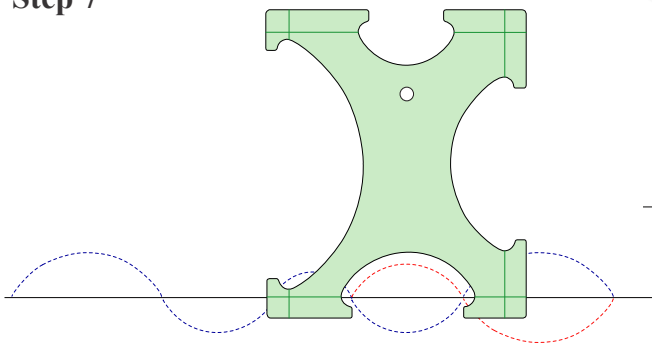

Step 8

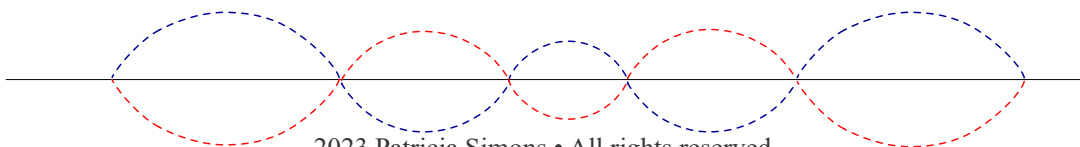
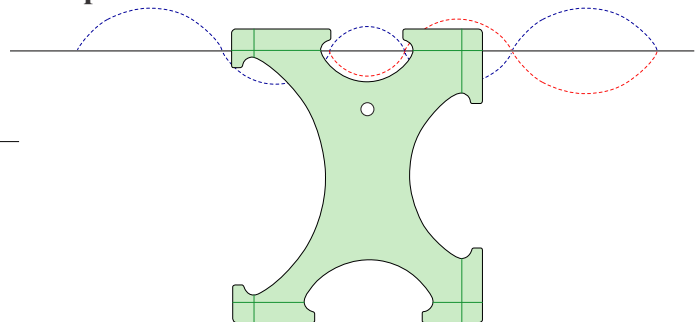

Interlocking Chain

Once you have completed one chain, start a second chain in the middle of the first link. (See Illustrations)

MQT-L01: Step 1

Step 2

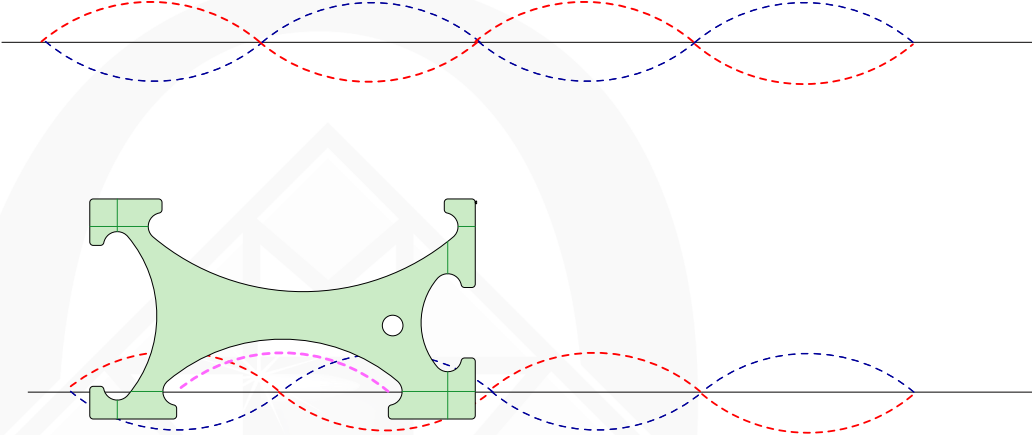

Step 3

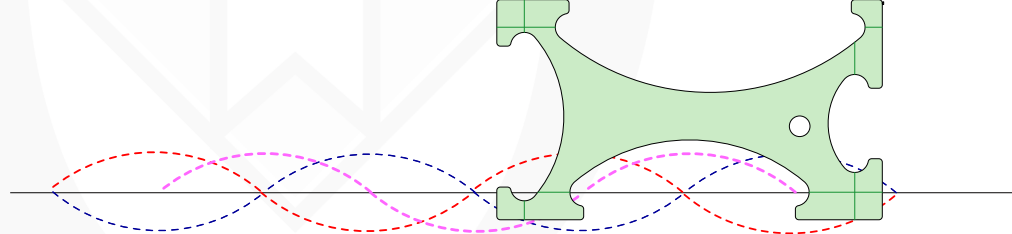

Step 4

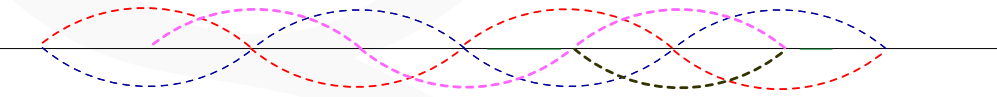

Step 5

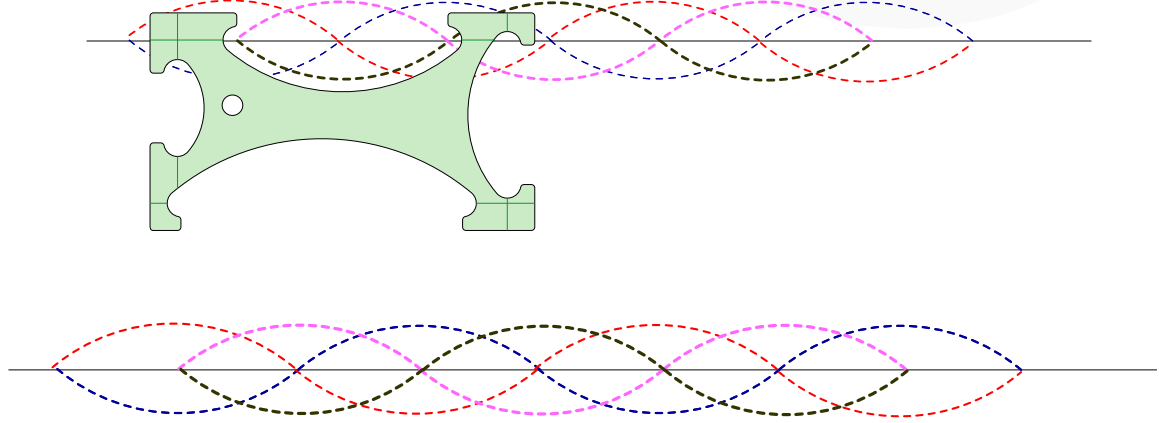

Interlocking Chain - Continued

MQT-L02: Step 1

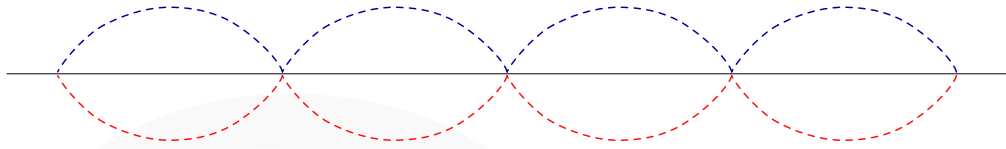

Step 2

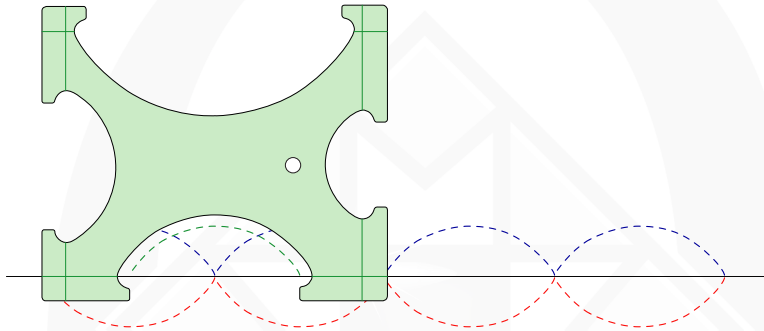

Step 3

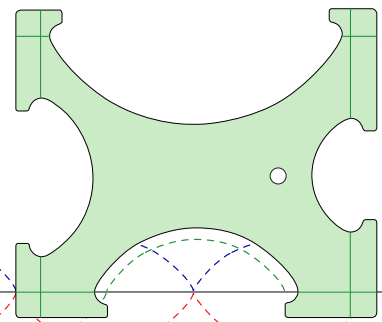

Step 4

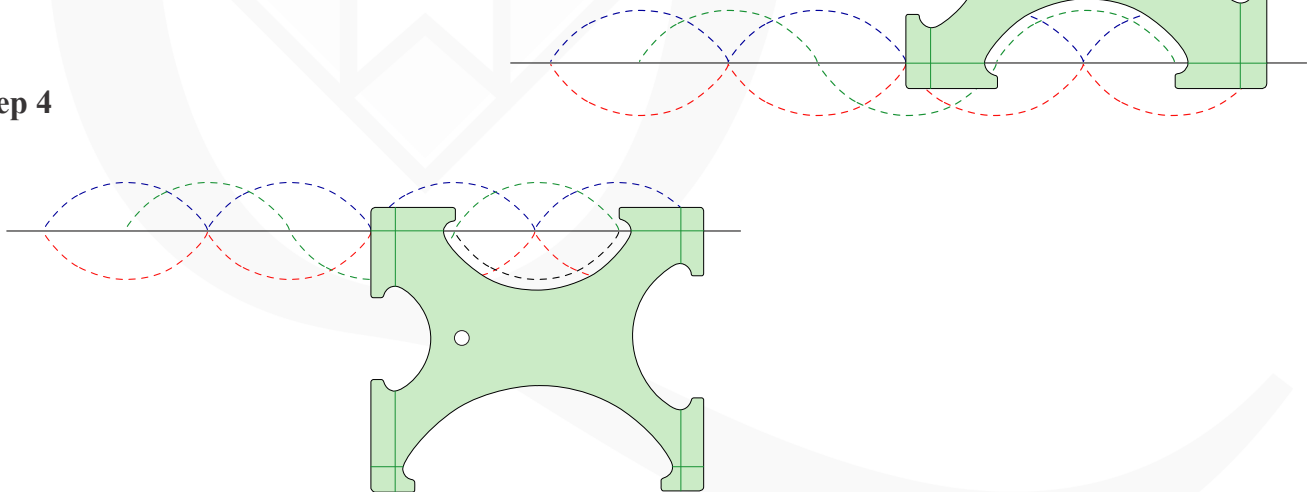

Step 5

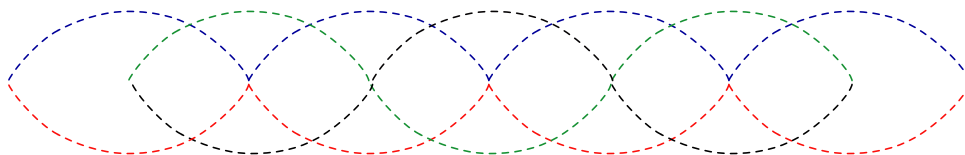
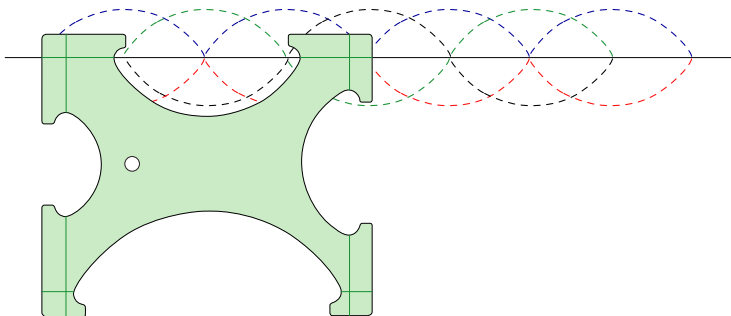

Chain Variation - Drop Leaf

Drop Leaf: Using the smallest opening and the largest opening, you can create a simple Drop Leaf chain.

The steps are:

- A. Left side of smallest leaf
- B. Right side of smallest leaf
- C. Left side of largest leaf

Step 1

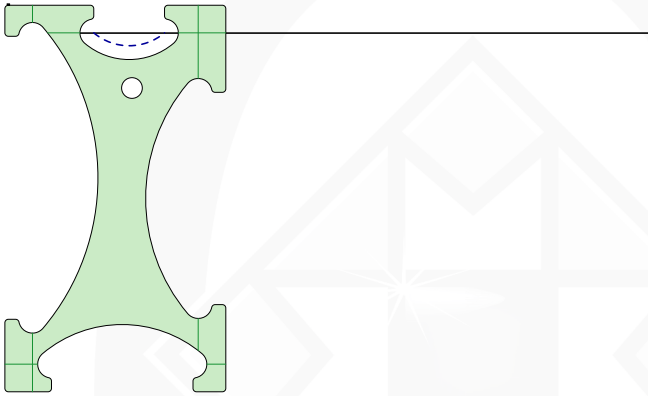

Step 2

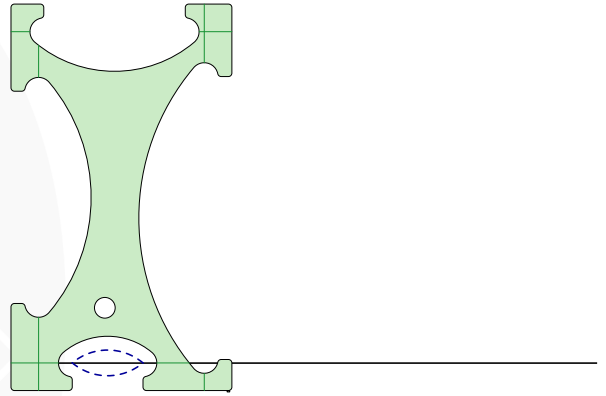

Step 3

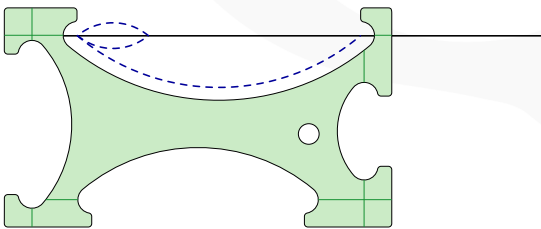

Step 4

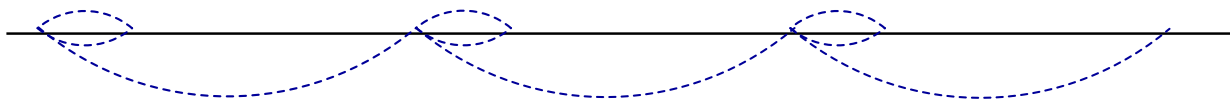
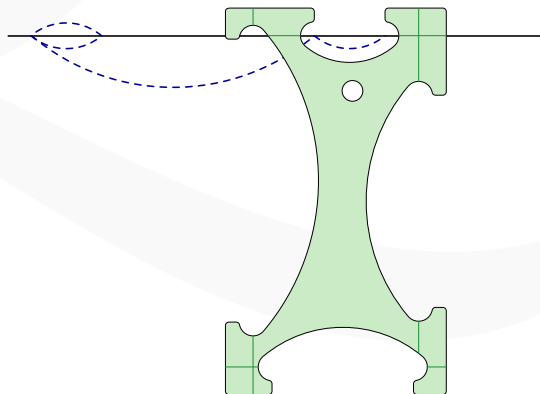

Chain Variations **MQT-L01**

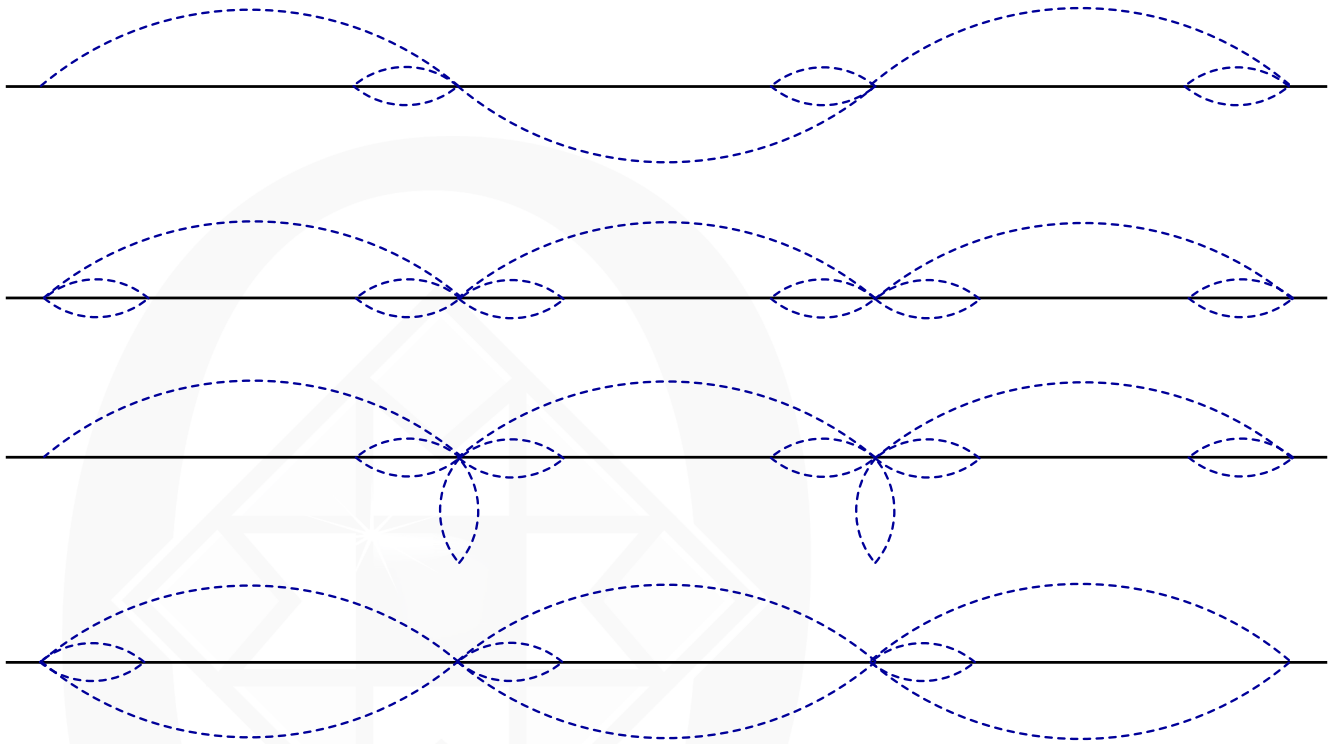

Chain Variations **MQT-L02**

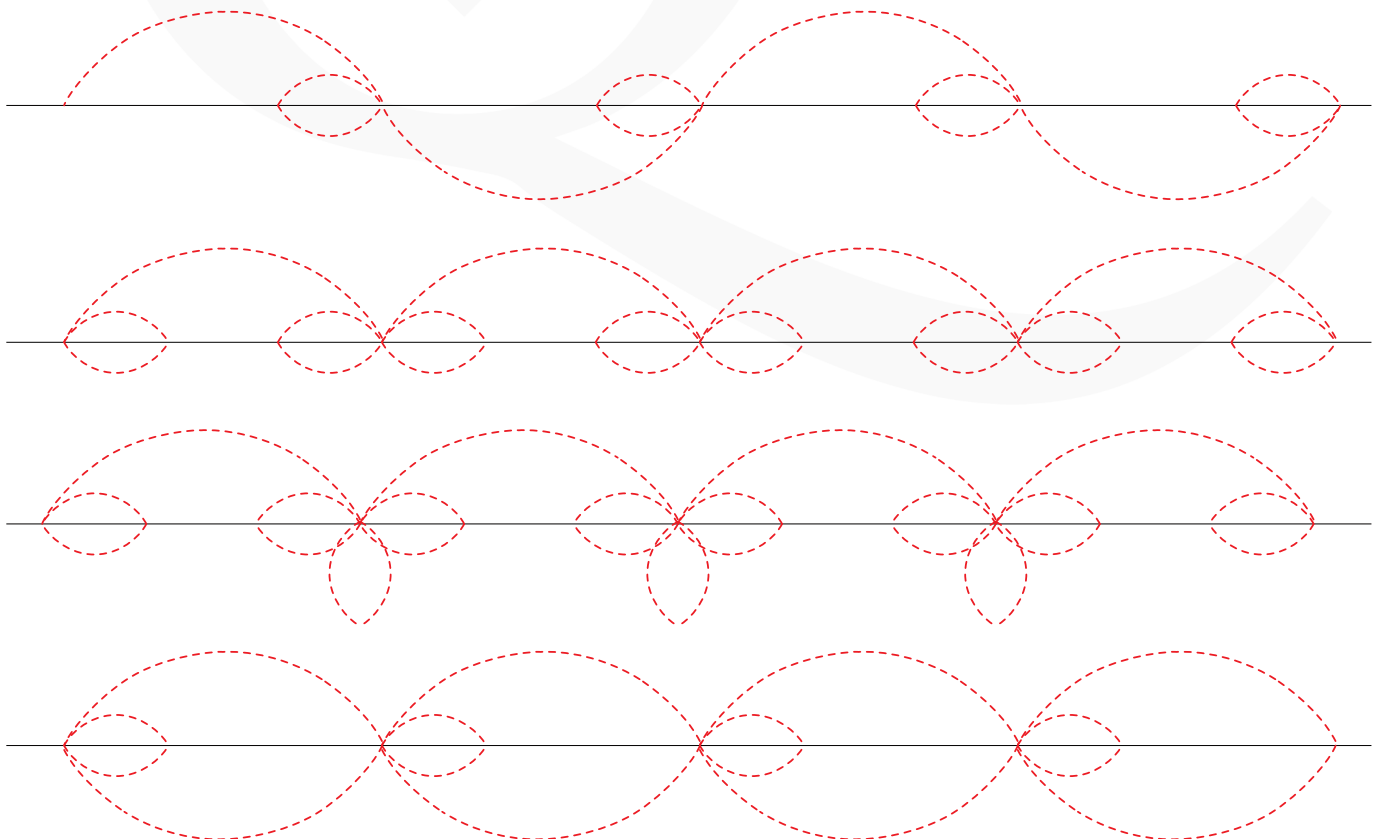

Flame Chain Variation

Using three of the sizes you can create a flame design.

MQT-L01: Step 1

Align the largest size with a seam or drawn line. Stitch the opening, moving forward. Needle down.

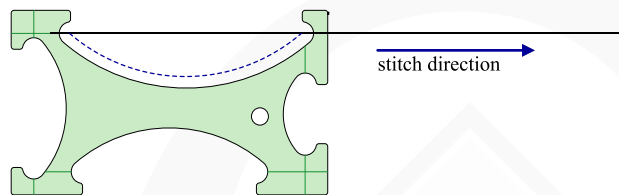

Step 2

Align the next size down with your foot so that you can stitch in the reverse direction. Stitch the opening. Needle down.

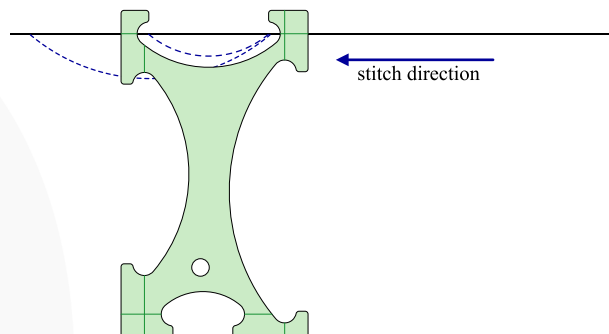

Step 3

Align the smallest size with your foot so that you can stitch in the reverse direction. Stitch the opening. Needle down

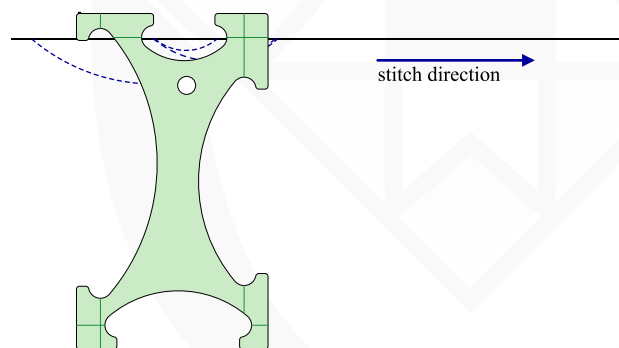

Step 4

Move the template to the other side of the seam or drawn line, This will allow you to “flip” the design. Repeat steps 1-3.

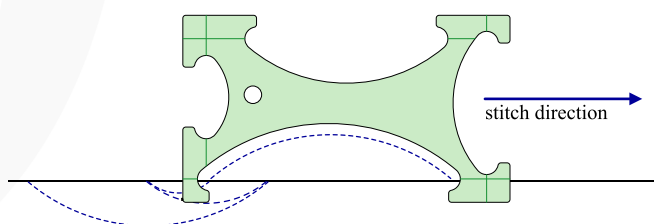

Step 5

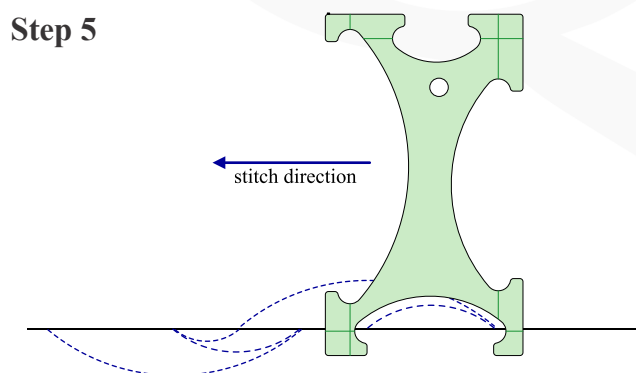

Step 6

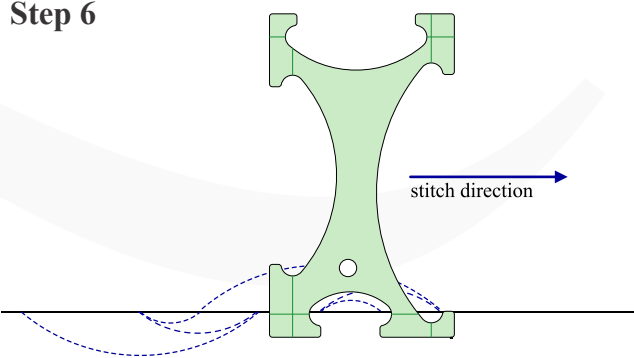

Step 7

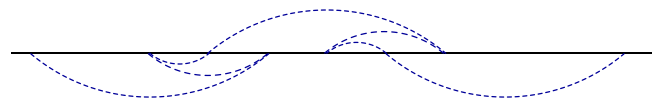
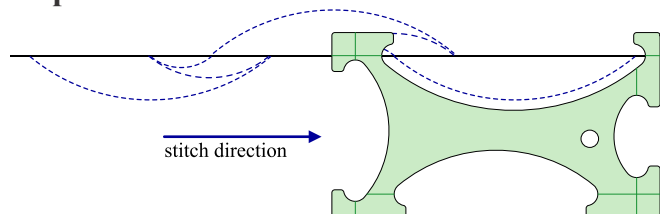

This design can be used with any three openings. You can start with the small or large opening.

Remember the stitch path is forward, back, forward. Flip template to the other side of the line then stitch forward, back, forward.

Flame Chain Variation (continued)

MQT-L02 Step 1

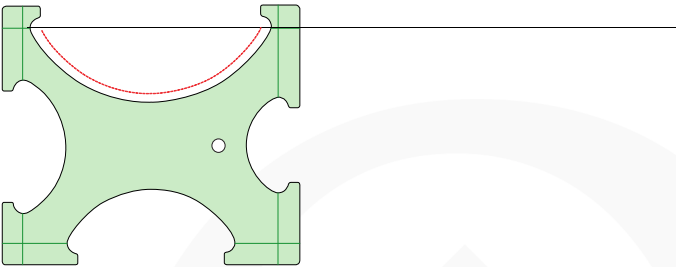

Step 2

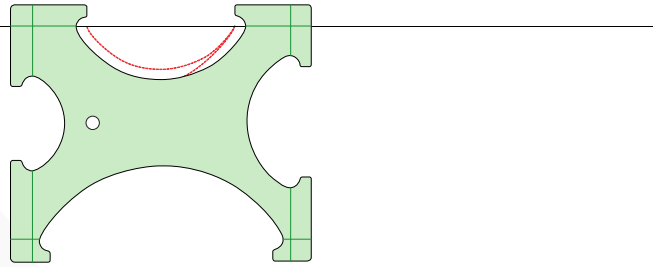

Step 3

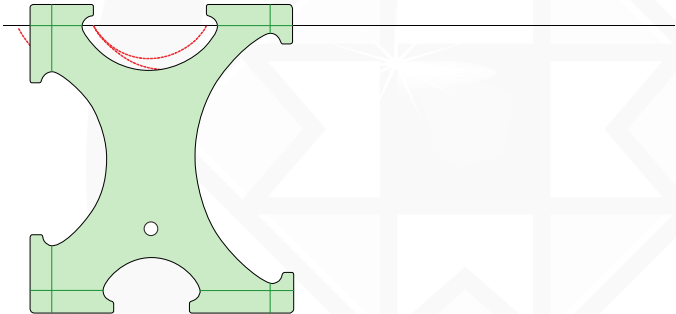

Step 4

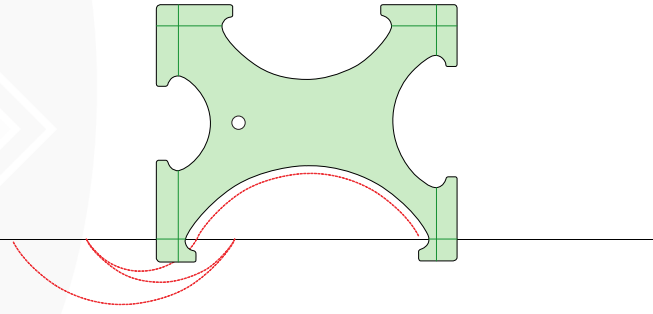

Step 5

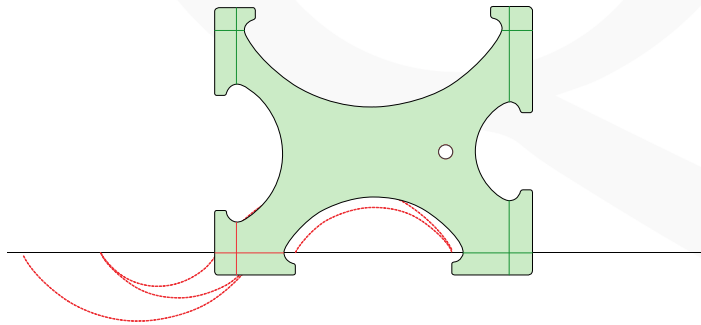

Step 6

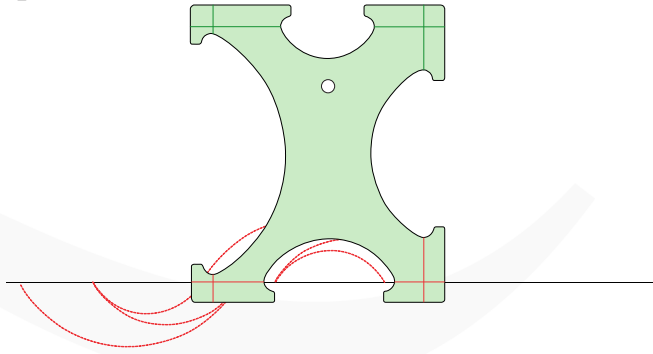

Step 7

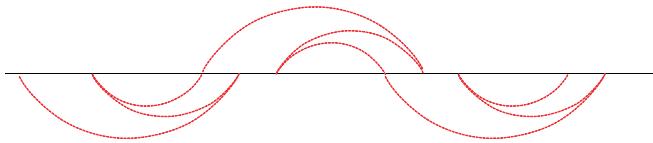
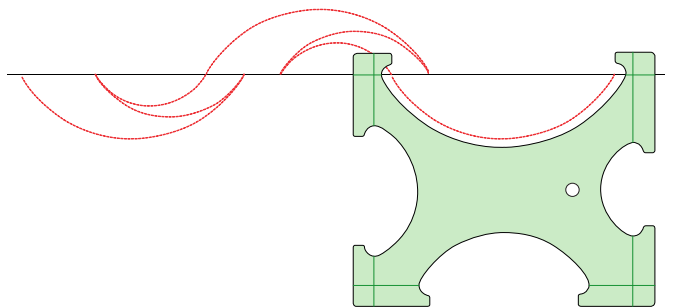

Chain Variation - Umbrella

Umbrella - Uses the two smallest openings. The steps are:

- A. The second smallest opening all the way down the line.
- B. The smallest opening back up the line. Two small ones fit inside one larger one.

Step 1

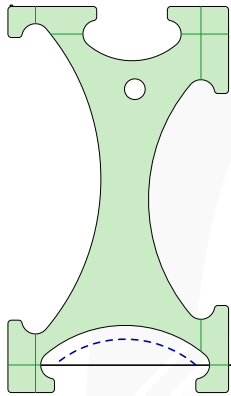

Step 2

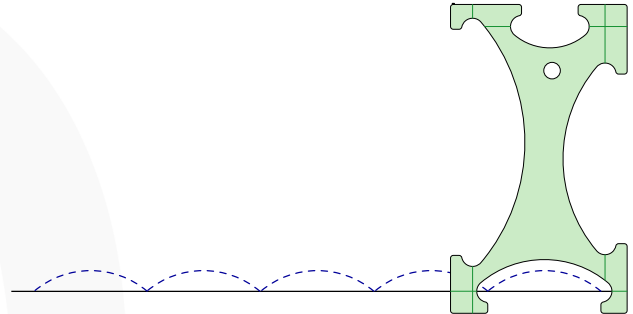

Step 3

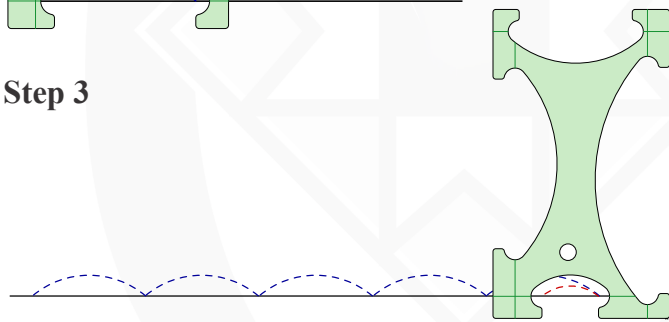

Step 4

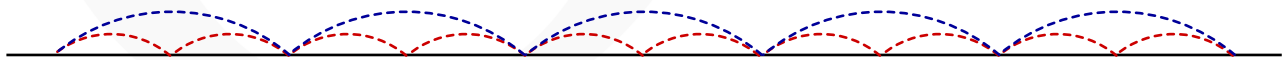
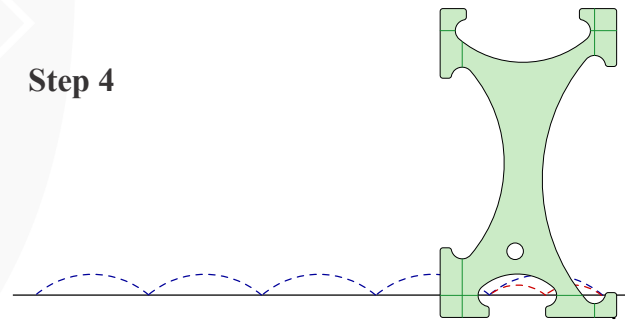

Chain Variation - Apostrophe

Apostrophe - Uses the two smallest openings. The steps are:

- A. The second smallest opening all the way down the line.
- B. The smallest opening in a "wave" Pattern.

Step 1

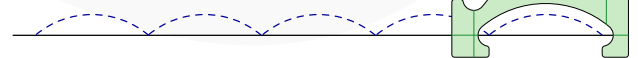

Step 2

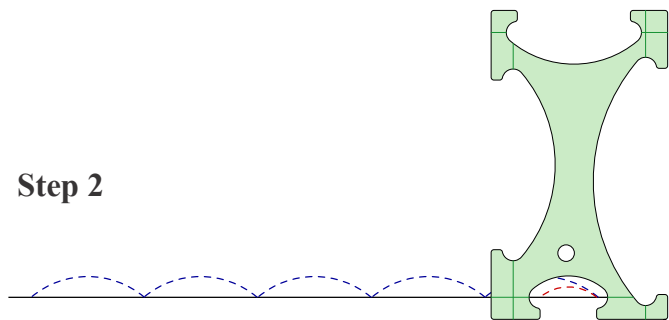

Step 3

Repeat step 2 and 3 to completion.

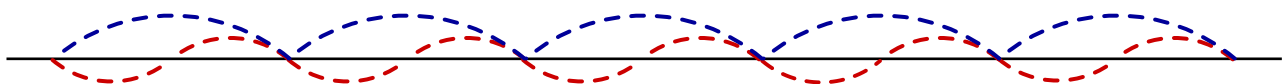
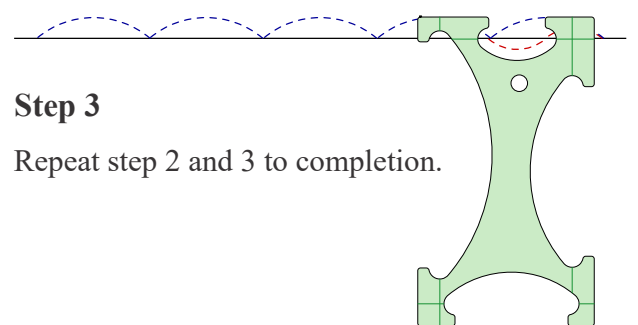

Cable Variation - *Creates a 4 line cable*

MQT-L01 Step 1

Line up the tool on the drawn line with the horizontal solid dashed line.
Use side D to make the first stitch.

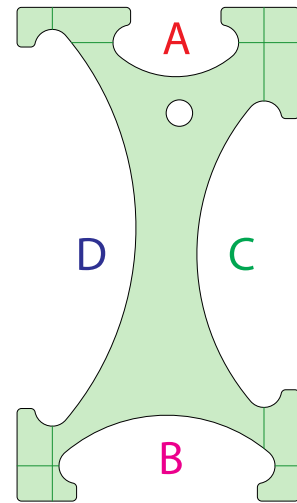
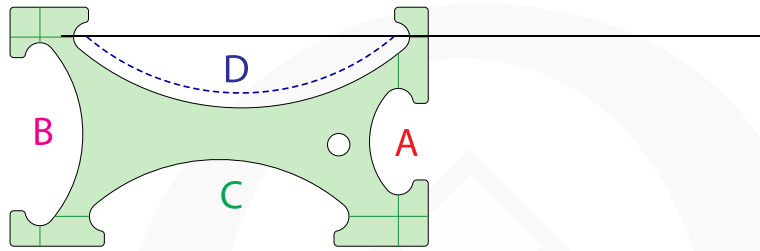

Step 2

Flip to the other side of the line.
Use side A to stitch down.

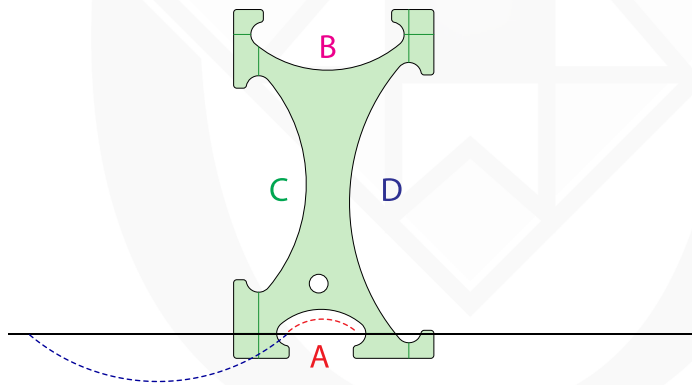

Step 3

Flip to other side of the line and use side D.
Repeat until line is complete.

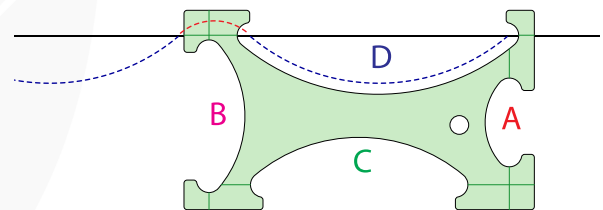

Step 4

Complete chain by working back up the line.

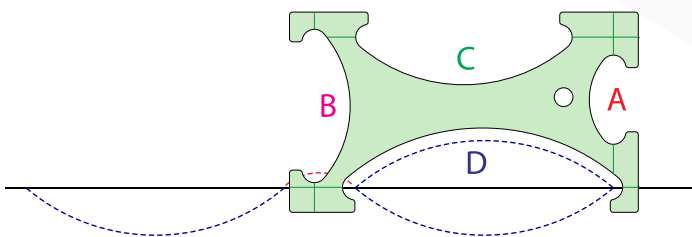

Step 5

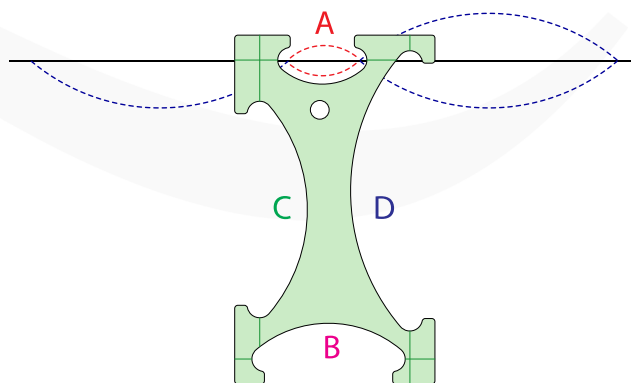

Step 6

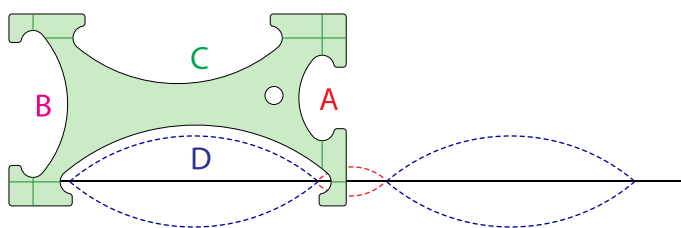

Cable Variation - Continued

The next row is completed by centering side C within the sewn oval made by side D. Stitch opening.

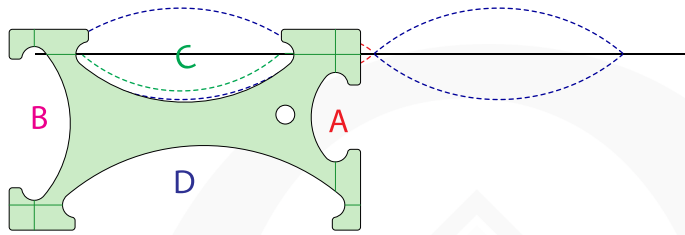

Slide the template down and flip to other side of the line and use opening B.

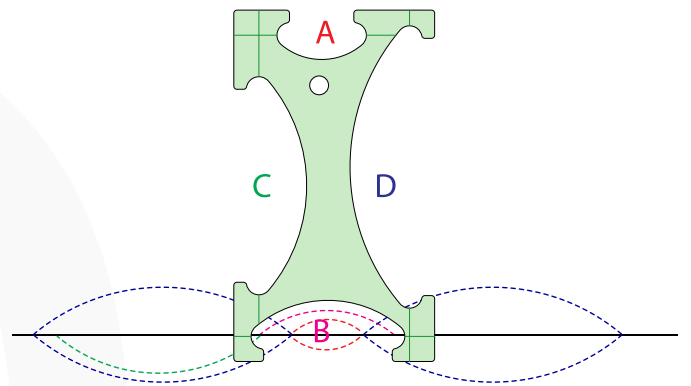

Cable Stitch

First pass use D and A.

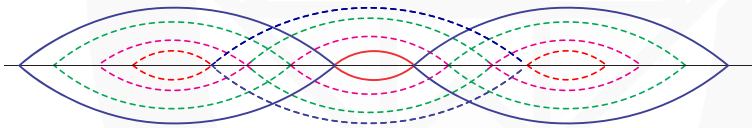

Second pass use C and B.

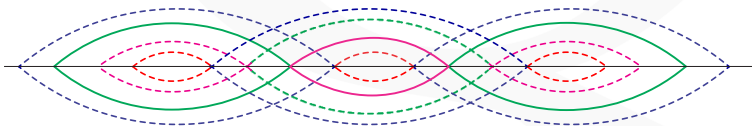

Third pass use B and C.

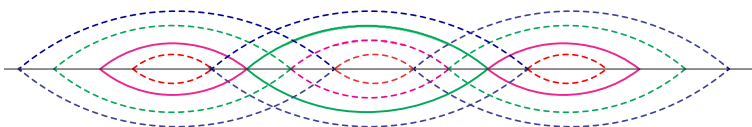

Fourth pass use A and D.

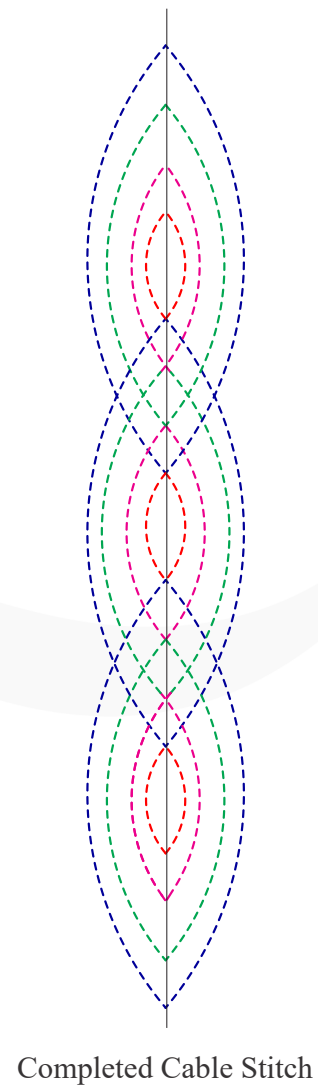
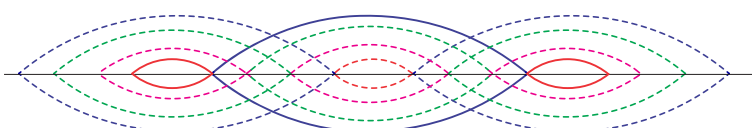

Completed Cable Stitch

Cable Variation - *Creates a 3 line cable*

MQT-L02 Step 1

Line up the tool on the drawn line with the horizontal solid dashed line. Use side D to make the first stitch.

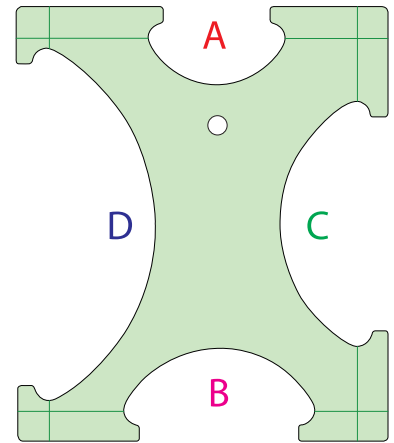
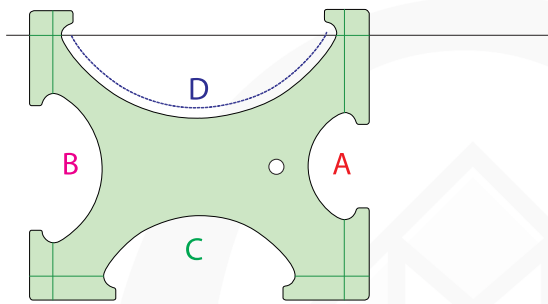

Step 2

Flip to the other side of the line. Use side A to stitch down.

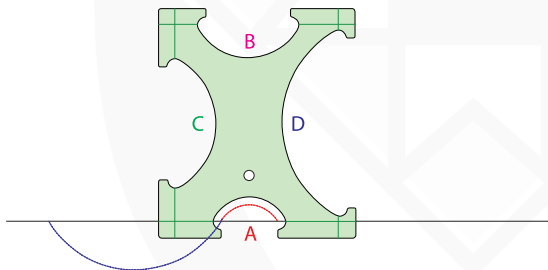

Step 3

Flip to other side of the line and use side D. Repeat until line is complete.

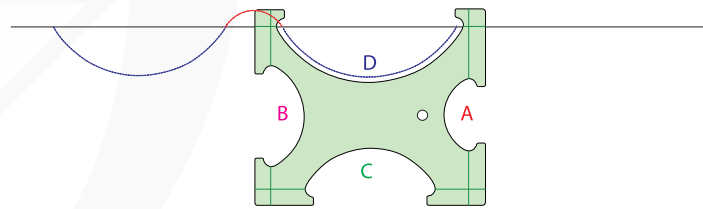

Step 4

Complete chain by working back up the line.

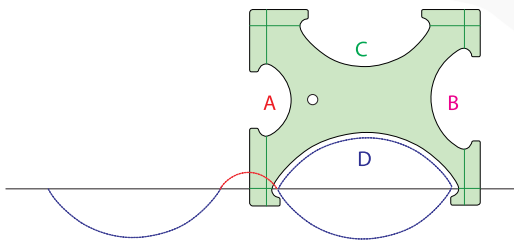

Step 5

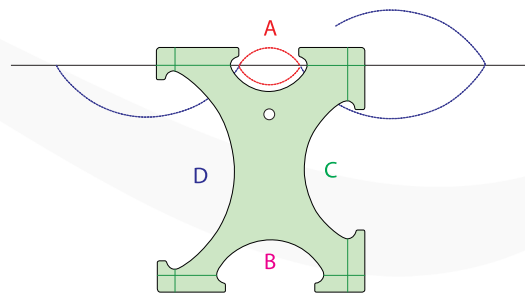

Step 6

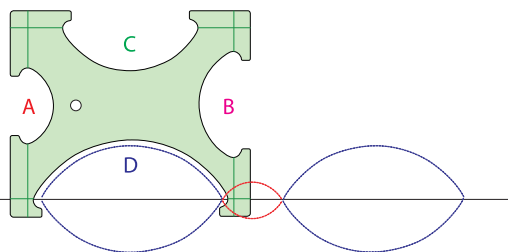

Step 7

The next row is completed by centering side C within the sewn oval. Stitch opening.

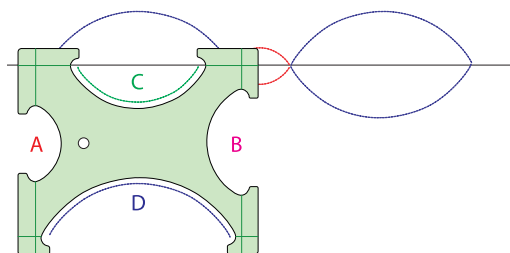

Cable Variation - *Continued*

Step 8

Slide the template down and flip to otherside of the line using opening C.

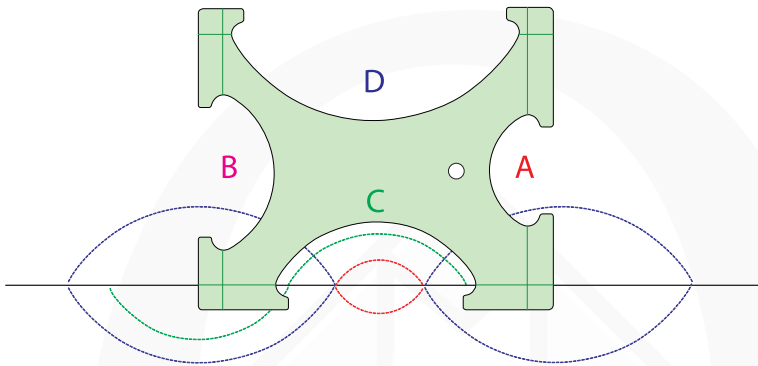

Cable stitch

First pass use D and A.

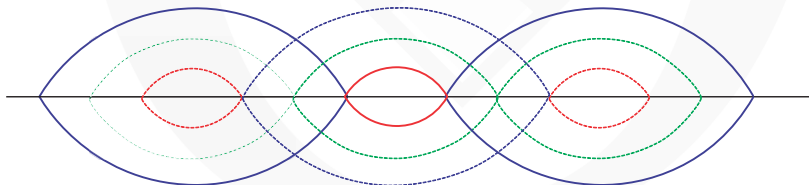

Step 8

Second pass use C.

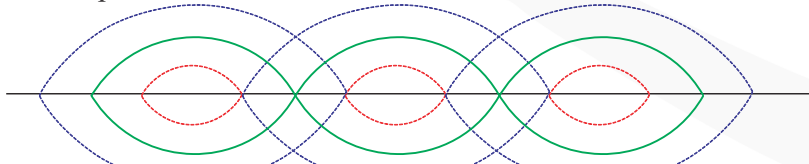

Step

Step

Step 8

Third pass use A and D.

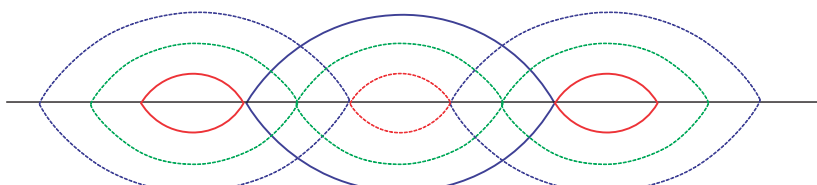

Step 8

Step 8

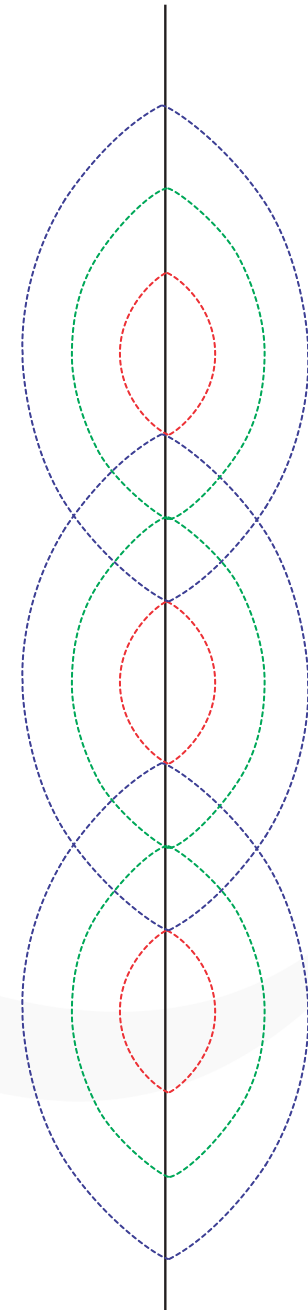

Completed Cable Stitch

Star Variation

MQT-L01: Step 1

Draw or chalk an eight point grid on your block. With your foot at the center, hook one end of an opening around the foot lining up the lines on the block. Stitch from the center to the outer edge. Needle down.

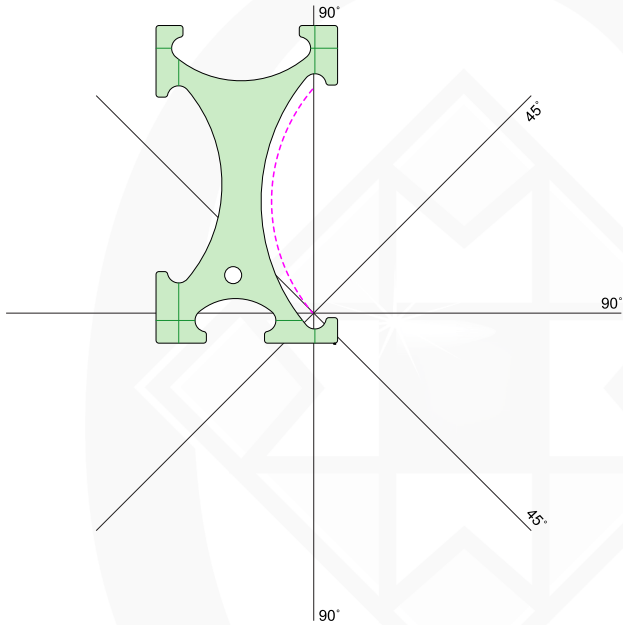

Step 2

Flip the tool around the foot lining up the lines on the tool with the lines on the block. Stitch from the outer edge to the center. Needle down.

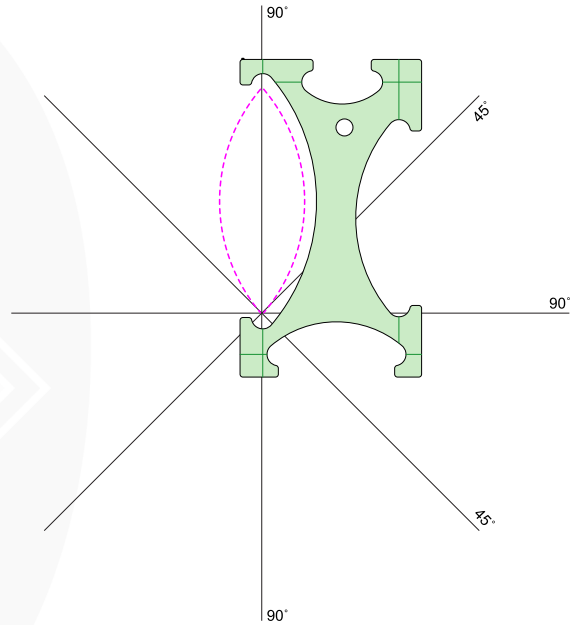

Step 3

Rotate to the next line and repeat.

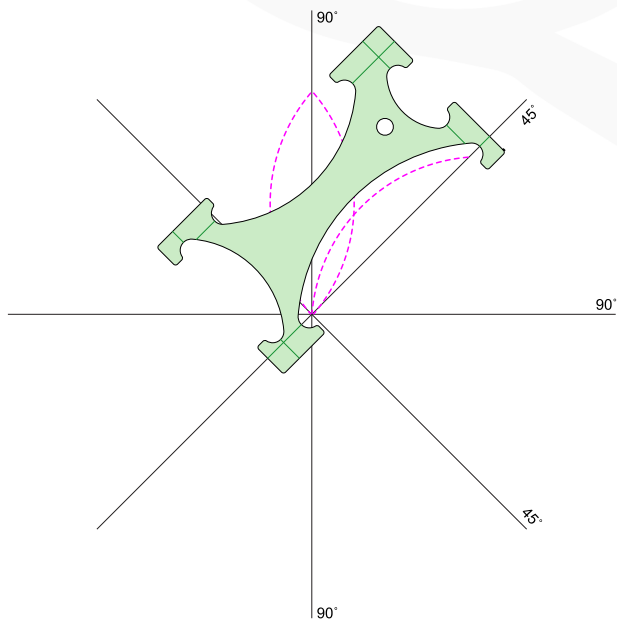

Completed Star

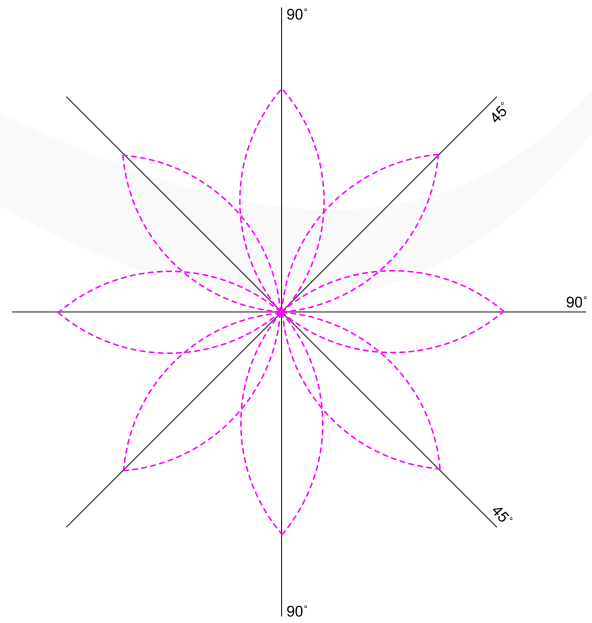

Leaf/Oval Variations MQT-L01

Star Variation #1

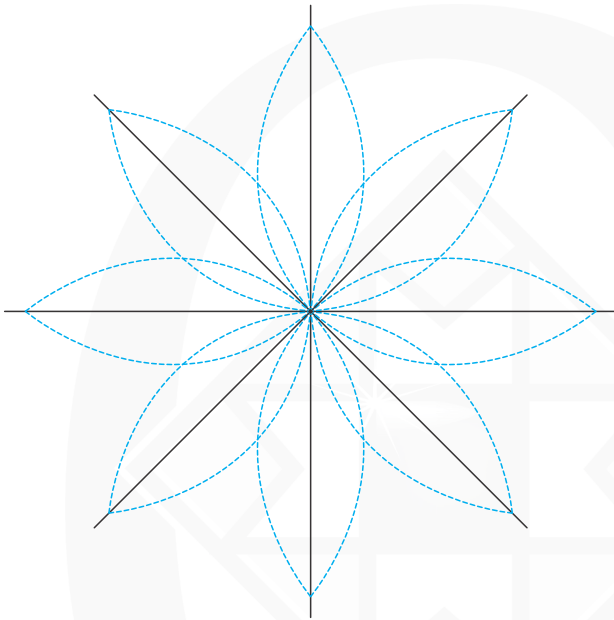

Variation #2
Using two different sizes of leaf/oval

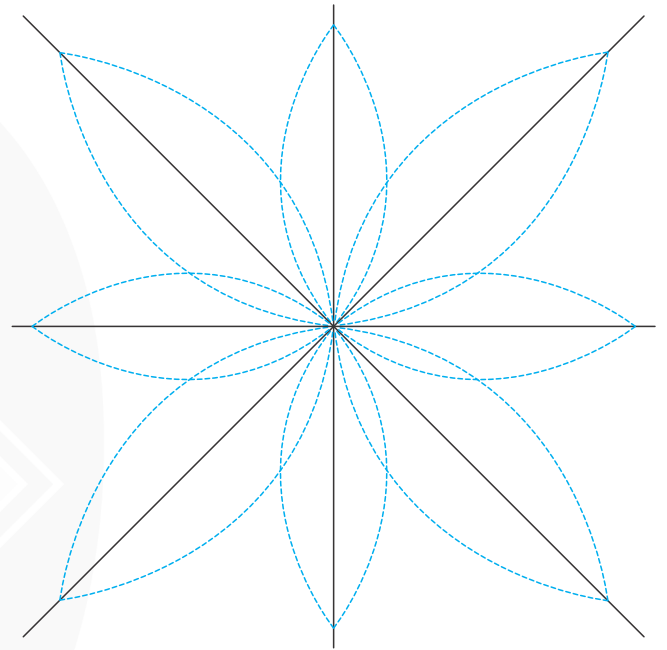

Variation #3
Using a six point grid and two sizes of leaf/oval

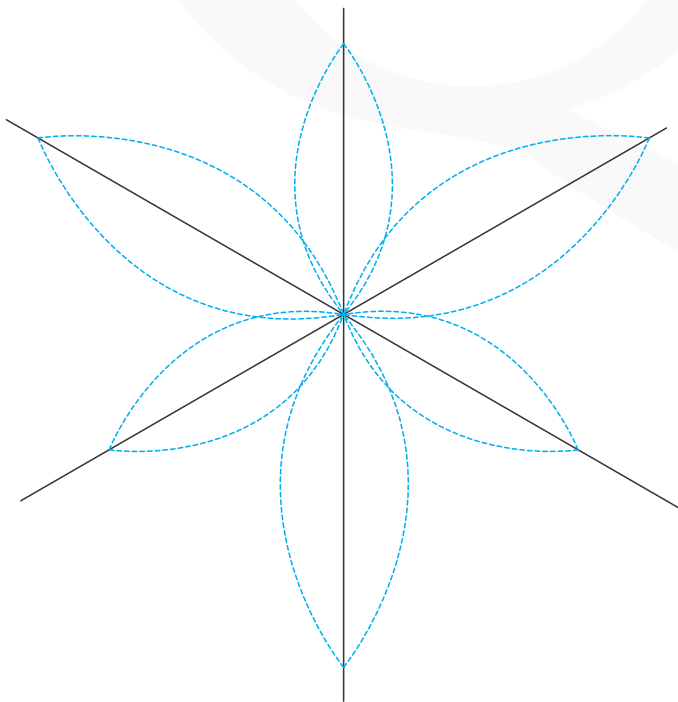

Variation #3
Using a six point grid and all sizes

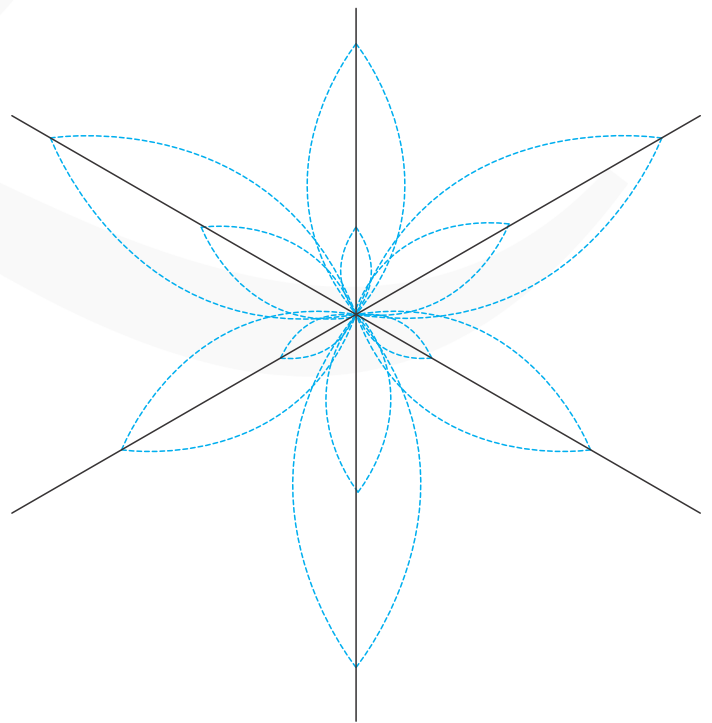

Leaf/Oval Variations **MQT-L02**

Variation #1

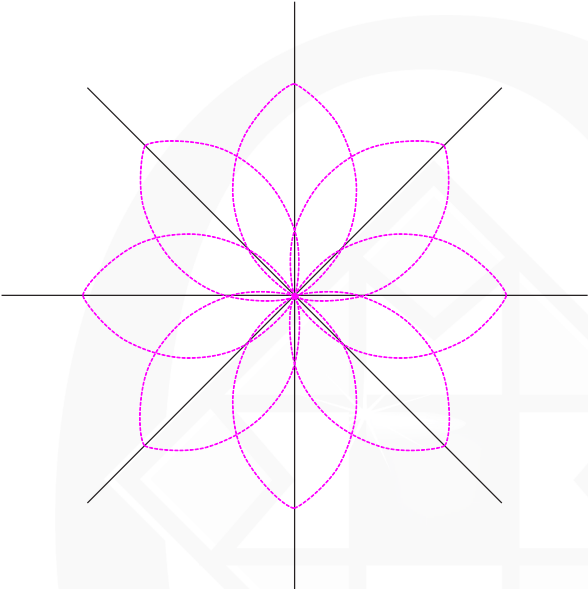

Variation #2

Using two different sizes of leaves

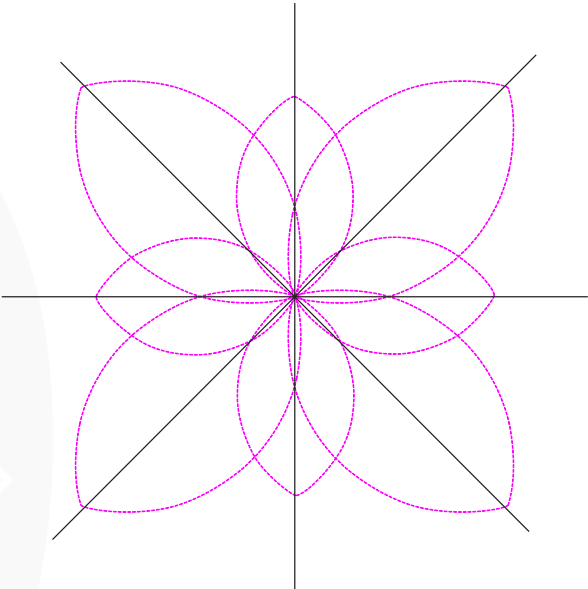

Variation #3

Using a six point grid and two sizes of ovals

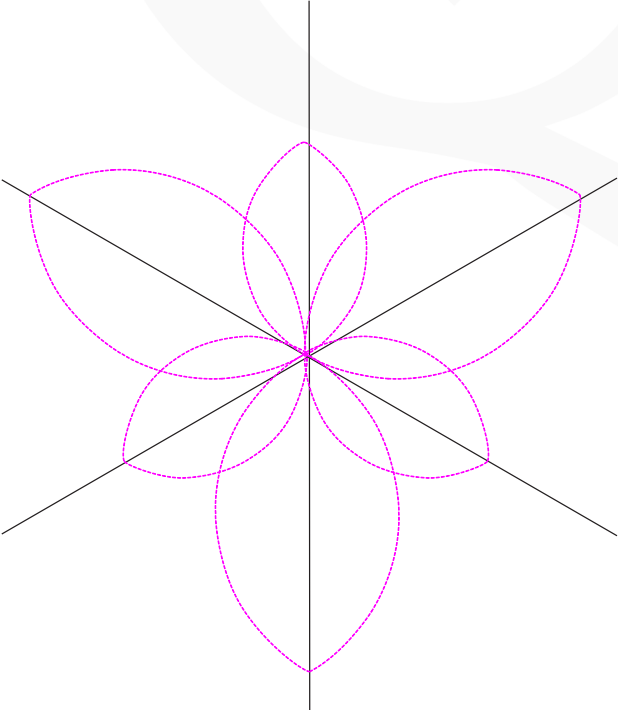

Variation #4

Using a six point grid and all sizes

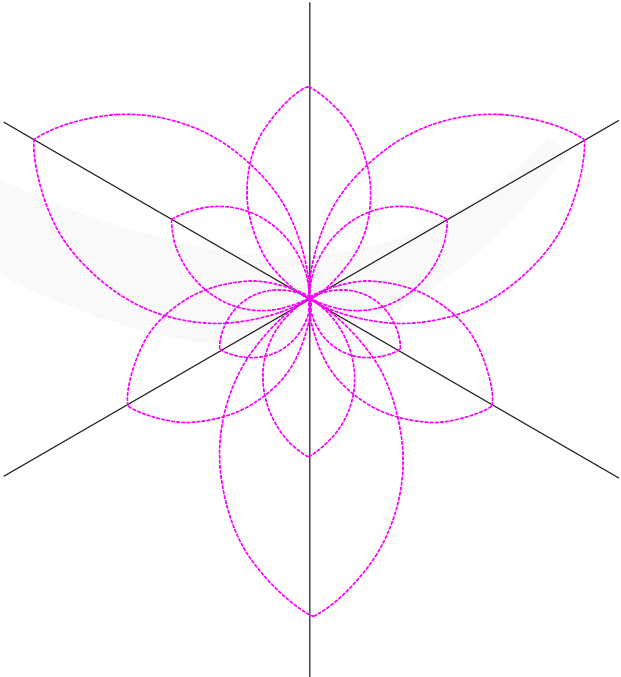

Complex Design

Continuous 3 Arc Interlock

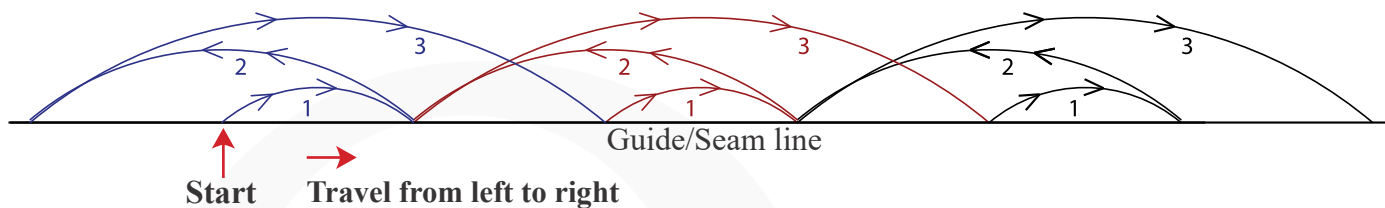

Creating a 3 Arc Interlocking Border

Step 1- We have numbered the sizes for ease of explaining. Line up the EZ2C® Registration Lines on the tool with your drawn guide line or seam line. Stitch following the directions of the arrows. Start with Arc 1, stitch from left to right, stopping at guide/seam line. Needle down.

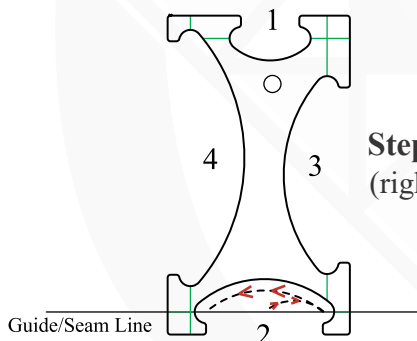
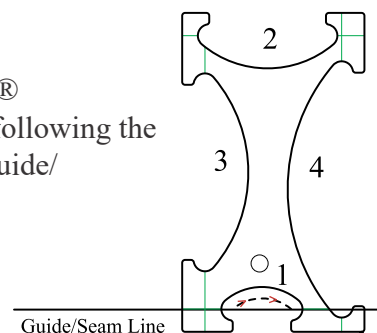

Step 2 - Rotate tool to Arc 2. Stitch following the direction of the arrows (right to left). Stop at guide/seam line. Needle down.

Step 3 - Rotate tool to Arc 3. Stitch following the direction of the arrows (left to right). Needle down. This completes the first section of the 3 Arc Interlocking border.

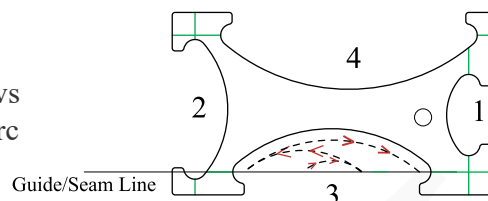

Step 4 - To continue, rotate tool to Arc 1, stitch left to right. Continue with steps 2 - 4 until you have completed your border.

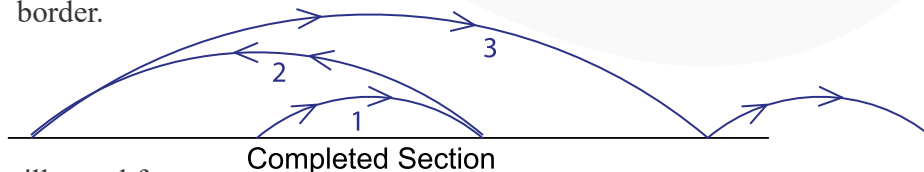

Note: Any 3 Arcs used will travel from left to right. Create a 4 Arc Interlock by using all sides. This border will travel from right to left.

Continuous 4 Arc Interlock

